

MERLYN[™]
ARYSTO



ULTIMATE SHOWERING EXPERIENCE
THE ARYSTO COLLECTION

AUG 2021

MERLYN™

Is a proud partner of the

pink ribbon
foundation +

MERLYN

ARYSTO

the ARYSTO COLLECTION

The MERLYN Arysto collection offers the perfect mix of ultra-modern design and expert craftsmanship, producing stunning shower enclosures that make the perfect centrepiece in your bathroom.

Revolutionary state-of-the-art technical innovations are used across the collection to achieve designs that have a beautifully crafted visual balance, making the virtually frameless enclosures gorgeous to look at and a pleasure to use.

Our flawless designs captivate with smooth flowing curves, crisp contemporary lines and show-stopping innovations. Whether you're relaxing or recharging, a MERLYN Arysto shower will transform your bathroom into a luxury escape.

Thank you for choosing a MERLYN Arysto shower.

The MERLYN Team

INDULGE IN THE ULTIMATE SHOWERING EXPERIENCE

ARYSTO
EIGHT



reddot design award
winner 2018

ARYSTO
SIX



The beautiful ARYSTO SIX range is a unique designer 6mm semi-frameless product that brings a minimal, sophisticated style to any bathroom. The signature glass cut-away creates a floating appearance that has been crafted to amplify and accentuate the lightness of design, without compromising the performance of the product.

- Height 1950mm
- Signature glass cut-out creates a crisp minimal enclosure
- Soft close rollers that glide to an extra smooth close



Introducing the stunning 'virtually frameless' ARYSTO EIGHT range, guaranteed to transform your bathroom space. Subtle design detailing such as the ultra slim frame has been used to enhance the 'virtually frameless' quality of the range. The chamfered edges reflect ambient light reducing the visual impact of the enclosures.

- Height 2000mm
- Ultra slim profiles and subtle design detailing enhance the quality of these enclosures
- Ultra smooth rolling action ensures this door effortlessly glides open and closed



The Arysto X is the ultimate in frameless design with luxury 10mm glass and an ergonomically crafted towel rail handle.

- Height up to 2000mm
- Eyelet handle option available

ARYSTO TEN



Smooth flowing curves, crisp contemporary lines and stunning frameless designs encapsulate the design essence of the Arysto Ten range. The innovation behind the design takes this range to the next level of luxury. The integration of the Halo Handle and profiles using soft ambient LED lighting create a definite show stopper in any bathroom. This range is beautifully crafted, available in every shape and size imaginable with many luxury Bespoke options available.

- Height up to 2015mm
- Designer hinges highly engineered to ensure smooth and solid opening and closing
- Bespoke options available

CONTENTS

The Arysto Collection

ARYSTO X

The Sliding Door Collection	1
The Wetroom Collection	7

ARYSTO TEN

The Sliding Door Collection	9
The Hinged Door Collection	23
The Wetroom Collection	43
The Bespoke Collection	51

ARYSTO EIGHT

55

ARYSTO SIX

73

The Bath Screen Collection	87
Shower Trays	93
Slip Resistant Trays	97
Product Information	105



MERLYN trays

The MERLYN tray collection offers a broad range of trays to suit every budget, from entry level to premium. We pride ourselves on being able to offer our customers quality manufactured products, the perfect complement for your Arysto shower enclosure backed up by outstanding customer service. Many of our trays feature a lifetime guarantee.

The shower trays featured in this brochure are our recommendations to compliment the Arysto range. To view our full range of trays, please visit www.merlynshowering.com

PREMIUM

LEVEL 25¹



- 25mm Sleek
- Fitted or level to floor
- 30 sizes available
- Price starting from £200

LEVEL 25¹-SR



- 25mm Sleek
- Fitted or level to floor
- 21 sizes available
- Price starting from £300

TRUESTONE[®]



- Ultra slim 25mm low level tray can be fitted on or level with floor
- 15 sizes available in 5 different colours
- Price starting from £500

MID LEVEL

MSTONE[®]



- Double Skinned
- 30 sizes available
- Price starting from £195

TOUCHSTONE-SR



- Single Skinned
- 30 sizes available
- Price starting from £200

MORE INFORMATION
AVAILABLE ON PAGE
93 OF BROCHURE

Five Colours

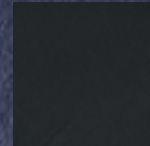

Black



Sandstone



Fossil Grey



White



Graphite

Choose your Shape

Rectangular Tray



Square Tray



Quadrant Tray



Offset Quadrant Tray



Left Handed (L) Right Handed (R)
This product is handed. Please choose L for Left or R for Right when ordering.

THE ULTIMATE TRAY EXPERIENCE

MERLYN revo

Available Now

Revo unlocks the shower's functionality a sleek storage system and a steadying hand for all the family: independent kids learning to shower; shampoo collections organized & clutter free; a helping hand for mothers to be; confidence for visiting grandparents; Revo is designed for living. A perfect accessory for your Arysto shower enclosure.



ARYSTO

COLOUR

Available Now

Arysto 10 Hinge and Inline in COLOUR

Please contact sales@merlyn.ie for more details.



Picture supplied by Tile Style - Dublin, Ireland

UP TO
2000
MM
HEIGHT
STANDARD DOOR

10^{MM}
GLASS
THICKNESS



SCAN ME

LIFETIME
GUARANTEE

MERSHIELD
STAYCLEAR

ARYSTO TEN

ARYSTO X

Escape from the everyday to a sanctuary of calm in the ARYSTO X

The Most Frameless Shower Door on the market.

Beneath the beautifully designed minimal frame lies a highly technical shower enclosure that gives the ARYSTO X its class leading functionality. To create a frameless 10mm door every element of its design and engineering has been pushed to perform multiple tasks.

MERLYN will donate **£25** from the sale of each ARYSTO X to the



pink ribbon
foundation





Sliding Door with Side Panel shown as Right Hand (R)

SLIDING DOOR WITH SIDE PANEL

Features & Benefits

- › Ultra frameless
- › Self cleaning anti jump rollers
- › Towel rail handle included as standard
- › Low threshold for easy access
- › Very smooth and quiet rolling action
- › Eyelet handle available
- › Power shower suitable
- › Wetroom compatible
- › Concealed fixings
- › Concealed inline support bar



Product Information

Size	Code	Adjustment Min-Max	Price £ Exc. VAT	Price £ Inc. VAT
1000	ARXFSL100 (L or R)	965-985	1706.90	2048.28
1100	ARXFSL110 (L or R)	1065-1085	1706.90	2048.28
1200	ARXFSL120 (L or R)	1165-1185	1713.77	2056.52
1300	ARXFSL130 (L or R)	1265-1285	1785.89	2143.07
1400	ARXFSL140 (L or R)	1365-1385	1923.26	2307.92
1500	ARXFSL150 (L or R)	1465-1485	2001.11	2401.33
1600	ARXFSL160 (L or R)	1565-1585	2020.57	2424.69
1700	ARXFSL170 (L or R)	1665-1685	2034.31	2441.17
1800	ARXFSL180 (L or R)	1765-1785	2129.33	2555.19

This product is handed – please choose L for Left and R for Right when ordering.

Please Note: To order an eyelet handle, add E to the end of the code, followed by handing (L or R) e.g. ARXFSL100EL / ARXFSL100ER.

Please Note: Images are for illustrative purposes only. Please refer to the installation guide when fitting the product.

Side Panel

Size	Code	Adjustment Min-Max	Price £ Exc. VAT	Price £ Inc. VAT
760	ARXFPSL76	730-750	565.53	678.64
800	ARXFPSL80	770-790	607.89	729.47
900	ARXFPSL90	870-890	691.46	829.75
1000	ARXFPSL100	970-990	802.50	963.01

Select Handle



To order an eyelet handle, add E to the end of the code, followed by handing (L or R). e.g.

ARXFSL100EL / ARXFSL100ER

Technical Drawing



A: Moving Panel
B: Fixed Panel
X: Door Opening

Size	Door Opening	Moving Panel A	Fixed Panel B
1000	385	505	440
1100	435	555	490
1200	485	605	540
1300	535	655	590
1400	585	705	640
1500	585	705	740
1600	585	705	840
1700	585	705	940
1800	585	705	1040

Please Note: If fitting the eyelet handle, please consider the direction of your shower head.
Alternative 1000mm, 90° support bar available. Code ARXFSL90DEG.



Design is not what it looks like. Design is how it works.



Steve Jobs



Sliding Door with Side Panel shown as Right Hand (R)

SLIDING DOOR IN RECESS

ARYSTO X

THE SLIDING DOOR COLLECTION

Features & Benefits

- › Ultra frameless
- › Self cleaning anti jump rollers
- › Towel rail handle included as standard
- › Low threshold for easy access
- › Very smooth and quiet rolling action
- › Eyelet handle available
- › Power shower suitable
- › Wetroom compatible
- › Concealed fixings
- › Concealed inline support bar



Product Information

Size	Code	Adjustment Min-Max	Price £ Exc. VAT	Price £ Inc. VAT
1000	ARXFSL100 (L or R)	965-1000	1706.90	2048.28
1100	ARXFSL110 (L or R)	1065-1100	1706.90	2048.28
1200	ARXFSL120 (L or R)	1165-1200	1713.77	2056.52
1300	ARXFSL130 (L or R)	1265-1300	1785.89	2143.07
1400	ARXFSL140 (L or R)	1365-1400	1923.26	2307.92
1500	ARXFSL150 (L or R)	1465-1500	2001.11	2401.33
1600	ARXFSL160 (L or R)	1565-1600	2020.57	2424.69
1700	ARXFSL170 (L or R)	1665-1700	2034.31	2441.17
1800	ARXFSL180 (L or R)	1765-1800	2129.33	2555.19

This product is handed – please choose L for Left and R for Right when ordering.

Please Note: 20mm adjustment on fixed panel side and 15mm adjustment on closing post side.

Please Note: To order an eyelet handle, add E to the end of the code, followed by handing (L or R) e.g.

ARXFSL100EL / ARXFSL100ER.

Please Note: Images are for illustrative purposes only. Please refer to the installation guide when fitting the product.

Size	Code	Price £ Exc. VAT	Price £ Inc. VAT
1000	ARXFSL90DEG	147.68	177.22

Alternative support option (90° bar)

Select Handle



To order an eyelet handle, add E to the end of the code, followed by handing (L or R). e.g.

ARXFSL100EL / ARXFSL100ER

Technical Drawing



A: Moving Panel
B: Fixed Panel
X: Door Opening

Size	Door Opening	Moving Panel A	Fixed Panel B
1000	385	505	440
1100	435	555	490
1200	485	605	540
1300	535	655	590
1400	585	705	640
1500	585	705	740
1600	585	705	840
1700	585	705	940
1800	585	705	1040

Please Note: If fitting the eyelet handle, please consider the direction of your shower head.



Fashion fades, only style
remains the same.



Coco Chanel



Sliding Door in Recess shown with eyelet handle as Right Hand (R)

WETROOM

ARYSTOX

THE SLIDING DOOR COLLECTION

Features & Benefits

- › Ultra frameless
- › Self cleaning anti-jump rollers
- › Eyelet handle available
- › Wetroom compatible
- › Concealed fixings
- › Space saving solution
- › Extensive splash protection
- › Sliding door moves in front of the fixed panel creating the largest possible entry area!



Product Information

Size	Code	Adjustment Min-Max	Price £ Exc. VAT	Price £ Inc. VAT
1000	ARXFSL100SW (L or R)	950-970	1762.99	2115.59
1100	ARXFSL110SW (L or R)	1050-1070	1762.99	2115.59
1200	ARXFSL120SW (L or R)	1150-1170	1769.86	2123.83
1300	ARXFSL130SW (L or R)	1250-1270	1841.98	2210.38
1400	ARXFSL140SW (L or R)	1350-1370	1979.36	2375.23
1500	ARXFSL150SW (L or R)	1450-1470	2057.21	2468.65
1600	ARXFSL160SW (L or R)	1550-1570	2076.67	2492.00
1700	ARXFSL170SW (L or R)	1650-1670	2090.40	2508.49
1800	ARXFSL180SW (L or R)	1750-1770	2185.42	2622.51

Please Note: To order an eyelet handle, add E to the end of the code, followed by handing (L or R) e.g. ARXFSL100SWEL / ARXFSL100SWER.

Please Note: Images are for illustrative purposes only. Please refer to the installation guide when fitting the product.

Select Handle



To order an eyelet handle, add E to the end of the code, followed by handing (L or R). e.g.

ARXFSL100SWEL / ARXFSL100SWER

Technical Drawing

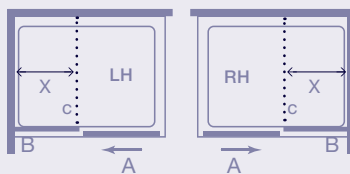

A: Moving Panel
 B: Fixed Panel
 C: Support Bar
 X: Distance to support bar (only on Wetroom Panels)

Size	Fully Opened	Fully Closed	X
1000	545	940	460-480
1100	595	1040	510-530
1200	645	1140	560-580
1300	695	1240	610-630
1400	745	1340	660-680
1500	845	1440	760-780
1600	945	1540	860-880
1700	1045	1640	960-980
1800	1145	1740	1060-1080

//
Form
follows
function.

//
Louis Sullivan



ARYSTO X Sliding Wetroom Panel shown as Right Hand (R)

UP TO
2015
MM
HEIGHT
STANDARD RANGE

10^{MM}
GLASS
THICKNESS

LIFETIME
GUARANTEE

MERSHIELD
STAYCLEAR

ARYSTO TEN

The stunning ARYSTO TEN Collection is the result of years of design and engineering research. This range showcases unique and stylish features innovative design and engineering solutions like the AirGlyde Dual Track Rolling System.

These stunning and luxurious shower enclosures have been beautifully crafted using the highest quality materials.

Exquisitely designed, expertly manufactured, the ARYSTO TEN Collection is the next level.





3 Panel Sliding Door with Side Panel shown as Left Hand (L) - featuring Halo Handle and Halo Profiles.

ARYSTO
TEN

THE SLIDING DOOR COLLECTION

Our superbly designed Sliding Doors have been precision engineered to effortlessly glide on our hidden AirGlyde dual track sliding system. Beautiful options such as our Halo Handle and Halo Profile make this a truly unique piece.

THE SLIDING DOOR COLLECTION





2 Panel Sliding Door with Side Panel

2 PANEL SLIDING DOOR IN RECESS

FREE
 MERLYN Wiper with each complete purchase of an Arysto Ten Product!



ARYSTO TEN

THE SLIDING DOOR COLLECTION

Features & Benefits

- Smooth flowing curves with crisp contemporary lines and frameless design details make this a true centrepiece for the bathroom.
- Ultra smooth rolling action and soft close door - Arysto AirGlyde Dual Track system ensures it effortlessly glides open and closed.
- Features such as Mersfield Stayclear easy clean glass and fully concealed fixings make this enclosure easy clean.
- Halo Handle and Profile options available - the warm ambient glow takes this enclosure to the next level of luxury.



Product Information

Size	Code	Adjustment Min-Max	Door Opening	Panel A Moving Panel	Panel B Fixed Panel	Price £ Exc. VAT	Price £ Inc. VAT
1000	GSR1000H (L or R)	960-990	370	528	430	1626.21	1951.45
1025	GSR1025H (L or R)	985-1015	370	528	455	1626.21	1951.45
1050	GSR1050H (L or R)	1010-1040	370	528	480	1626.21	1951.45
1075	GSR1075H (L or R)	1035-1065	370	528	505	1626.21	1951.45
1100	GSR1100H (L or R)	1060-1090	420	578	480	1626.21	1951.45
1125	GSR1125H (L or R)	1085-1115	420	578	505	1626.21	1951.45
1150	GSR1150H (L or R)	1110-1140	420	578	530	1626.21	1951.45
1175	GSR1175H (L or R)	1135-1165	420	578	555	1626.21	1951.45
1200	GSR2P1200H (L or R)	1160-1190	465	626	530	1632.73	1959.27
1400	GSR2P1400H (L or R)	1360-1390	566	723	635	1883.94	2260.73

This product is handed – please choose L for Left and R for Right when ordering.

Please Note: Images are for illustrative purposes only. Please refer to the installation guide when fitting the product.

Please Note: There is a minimum clearance of 100mm required above the shower enclosure to fix the top rail.

Select Handle

Handle

	Price £ Exc. VAT	Price £ Inc. VAT
1. Standard Sliding Handle		
2. Halo Handle	250.17	300.20



Select Halo Wall Profile

Halo Wall Profiles

	Price £ Exc. VAT	Price £ Inc. VAT
Fixed Panel Halo Profile	250.17	300.20
Closing Profile Halo Profile	250.17	300.20

Select Door Handling



Please clearly outline any additions to your order.



//
SIMPLICITY IS THE
ULTIMATE FORM OF
SOPHISTICATION.

//
Leonardo Da Vinci



2 Panel Sliding Door in Recess shown as Left Hand (L)

2 PANEL SLIDING DOOR WITH SIDE PANEL

FREE

MERLYN Wiper with each complete purchase of an Arysto Ten Product!



Features & Benefits

- Smooth flowing curves with crisp contemporary lines and frameless design details make this a true centrepiece for the bathroom.
- Ultra smooth rolling action and soft close door - Arysto AirGlyde Dual Track system ensures it effortlessly glides open and closed.
- Features such as Mersfield Stayclear easy clean glass and fully concealed fixings make this enclosure easy clean.
- Halo Handle and Profile options available - the warm ambient glow takes this enclosure to the next level of luxury.



Product Information

Size	Code	Adjustment Min-Max	Door Opening	Panel A Moving Panel	Panel B Fixed Panel	Price £ Exc. VAT	Price £ Inc. VAT
1000	GSC1000H (L or R)	983-998	380	528	430	1626.21	1951.45
1025	GSC1025H (L or R)	1008-1023	380	528	455	1626.21	1951.45
1050	GSC1050H (L or R)	1033-1048	380	528	480	1626.21	1951.45
1075	GSC1075H (L or R)	1058-1073	380	528	505	1626.21	1951.45
1100	GSC1100H (L or R)	1083-1098	430	578	480	1626.21	1951.45
1125	GSC1125H (L or R)	1108-1123	430	578	505	1626.21	1951.45
1150	GSC1150H (L or R)	1133-1148	430	578	530	1626.21	1951.45
1175	GSC1175H (L or R)	1158-1173	430	578	555	1626.21	1951.45
1200	GSC2P1200H (L or R)	1183-1198	473	626	530	1632.73	1959.27
1400	GSC2P1400H (L or R)	1383-1398	573	723	635	1883.94	2260.73

This product is handed – please choose L for Left and R for Right when ordering.

Side Panel

Size	Code	Adjustment Min-Max	Price £ Exc. VAT	Price £ Inc. VAT
700	GMSSP700C	670-685	511.99	614.39
760	GMSSP760C	730-745	538.97	646.76
800	GMSSP800C	770-785	579.49	695.39
900	GMSSP900C	870-885	658.26	789.91
1000	GMSSP1000C	970-985	764.03	916.83

For wetroom / grout line adjustment please contact Customer Services.

Please Note: Images are for illustrative purposes only. Please refer to the installation guide when fitting the product.

Please Note: There is a minimum clearance of 100mm required above the shower enclosure to fix the top rail

Select Handle

Handle

	Price £ Exc. VAT	Price £ Inc. VAT
1. Standard Sliding Handle		
2. Halo Handle	250.17	300.20



Select Halo Wall Profile

Halo Wall Profiles

	Price £ Exc. VAT	Price £ Inc. VAT
Fixed Panel Halo Profile	250.17	300.20
Side Panel Halo Profile	250.17	300.20

Select Door Handling

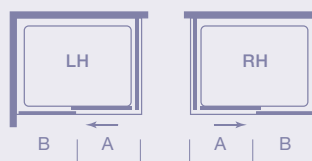

Please clearly outline any additions to your order.



FORM FOLLOWS
FUNCTION.



Louis Sullivan



2 Panel Sliding Door with Side Panel shown as Left Hand (L)

3 PANEL SLIDING DOOR IN RECESS

FREE

MERLYN Wiper with each complete purchase of an Arysto Ten Product!



Features & Benefits

- Smooth flowing curves with crisp contemporary lines and frameless design details make this a true centrepiece for the bathroom.
- Ultra smooth rolling action and soft close door - Arysto AirGlyde Dual Track system ensures it effortlessly glides open and closed.
- Features such as Mersfield Stayclear easy clean glass and fully concealed fixings make this enclosure easy clean.
- Halo Handle and Profile options available - the warm ambient glow takes this enclosure to the next level of luxury.



ARYSTO TEN

THE SLIDING DOOR COLLECTION

Product Information

Size	Code	Adjustment Min-Max	Door Opening	Panel A Moving Panel	Panel B Fixed Panel	Panel C Fixed Panel	Price £ Exc. VAT	Price £ Inc. VAT
1200	GSR1200H (L or R)	1160-1190	450	605	505	70	1632.73	1959.27
1225	GSR1225H (L or R)	1185-1215	450	605	505	95	1855.52	2226.62
1250	GSR1250H (L or R)	1210-1240	450	605	505	120	1862.25	2234.70
1275	GSR1275H (L or R)	1235-1265	450	605	505	145	1873.51	2248.21
1300	GSR1300H (L or R)	1260-1290	450	605	505	170	1883.94	2260.73
1325	GSR1325H (L or R)	1285-1315	450	605	505	195	1883.94	2260.73
1350	GSR1350H (L or R)	1310-1340	450	605	505	220	1883.94	2260.73
1375	GSR1375H (L or R)	1335-1365	450	605	505	245	1883.94	2260.73
1400	GSR1400H (L or R)	1360-1390	450	605	505	270	1883.94	2260.73
1425	GSR1425H (L or R)	1385-1415	450	605	505	295	1896.02	2275.23
1450	GSR1450H (L or R)	1410-1440	450	605	505	320	1896.02	2275.23
1475	GSR1475H (L or R)	1435-1465	450	605	505	345	1900.52	2280.62
1500	GSR1500H (L or R)	1460-1490	600	755	655	70	1900.52	2280.62
1525	GSR1525H (L or R)	1485-1515	600	755	655	95	1963.53	2356.24
1550	GSR1550H (L or R)	1510-1540	600	755	655	120	1963.53	2356.24
1575	GSR1575H (L or R)	1535-1565	600	755	655	145	1968.03	2361.63
1600	GSR1600H (L or R)	1560-1590	600	755	655	170	1968.03	2361.63
1625	GSR1625H (L or R)	1585-1615	600	755	655	195	2064.80	2477.75
1650	GSR1650H (L or R)	1610-1640	600	755	655	220	2069.31	2483.17
1675	GSR1675H (L or R)	1635-1665	600	755	655	245	2080.56	2496.67
1700	GSR1700H (L or R)	1660-1690	600	755	655	270	2117.31	2540.77
1725	GSR1725H (L or R)	1685-1715	600	755	655	295	2172.31	2606.77
1750	GSR1750H (L or R)	1710-1740	600	755	655	320	2172.31	2606.77
1775	GSR1775H (L or R)	1735-1765	600	755	655	345	2172.31	2606.77
1800	GSR1800H (L or R)	1760-1790	600	755	655	370	2172.31	2606.77

This product is handed – please choose L for Left and R for Right when ordering.

Select Handle

Handle

	Price £ Exc. VAT	Price £ Inc. VAT
1. Standard Sliding Handle		
2. Halo Handle	250.17	300.20



Please Note: There is a minimum clearance of 100mm required above the shower enclosure to fix the top rail.

Please Note: Images are for illustrative purposes only. Please refer to the installation guide when fitting the product.

Please clearly outline any additions to your order.

Select Halo Wall Profile

Halo Wall Profiles

	Price £ Exc. VAT	Price £ Inc. VAT
Fixed Panel Halo Profile*	250.17	300.20

*Must order 1 Profile for each side if required.

Select Door Handling

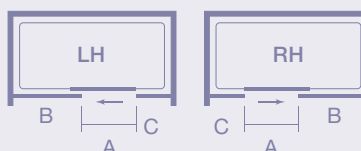



THE DETAILS ARE
NOT THE DETAILS.
THEY MAKE THE DESIGN.



Charles Eames



3 Panel Sliding Door in Recess with Halo Handle and Profiles shown as Left Hand (L)

3 PANEL SLIDING DOOR WITH SIDE PANEL

FREE

MERLYN Wiper with each complete purchase of an Arysto Ten Product!



Features & Benefits

- Smooth flowing curves with crisp contemporary lines and frameless design details make this a true centrepiece for the bathroom.
- Ultra smooth rolling action and soft close door - Arysto AirGlyde Dual Track system ensures it effortlessly glides open and closed.
- Features such as Mersfield Stayclear easy clean glass and fully concealed fixings make this enclosure easy clean.
- Halo Handle and Profile options available - the warm ambient glow takes this enclosure to the next level of luxury.



Product Information

Size	Code	Adjustment Min-Max	Door Opening	Panel A Moving Panel	Panel B Fixed Panel	Panel C Fixed Panel	Price £ Exc. VAT	Price £ Inc. VAT
1200	GSC1200H (L or R)	1168-1183	450	605	505	70	1632.73	1959.27
1225	GSC1225H (L or R)	1193-1208	450	605	505	95	1855.52	2226.62
1250	GSC1250H (L or R)	1218-1233	450	605	505	120	1862.25	2234.70
1275	GSC1275H (L or R)	1243-1258	450	605	505	145	1873.51	2248.21
1300	GSC1300H (L or R)	1268-1283	450	605	505	170	1883.94	2260.73
1325	GSC1325H (L or R)	1293-1308	450	605	505	195	1883.94	2260.73
1350	GSC1350H (L or R)	1318-1333	450	605	505	220	1883.94	2260.73
1375	GSC1375H (L or R)	1343-1358	450	605	505	245	1883.94	2260.73
1400	GSC1400H (L or R)	1368-1383	450	605	505	270	1883.94	2260.73
1425	GSC1425H (L or R)	1393-1408	450	605	505	295	1896.02	2275.23
1450	GSC1450H (L or R)	1418-1433	450	605	505	320	1896.02	2275.23
1475	GSC1475H (L or R)	1443-1458	450	605	505	345	1900.52	2280.62
1500	GSC1500H (L or R)	1468-1483	600	755	655	70	1900.52	2280.62
1525	GSC1525H (L or R)	1493-1508	600	755	655	95	1963.53	2356.24
1550	GSC1550H (L or R)	1518-1533	600	755	655	120	1963.53	2356.24
1575	GSC1575H (L or R)	1543-1558	600	755	655	145	1968.03	2361.63
1600	GSC1600H (L or R)	1568-1583	600	755	655	170	1968.03	2361.63
1625	GSC1625H (L or R)	1593-1608	600	755	655	195	2064.80	2477.75
1650	GSC1650H (L or R)	1618-1633	600	755	655	220	2069.31	2483.17
1675	GSC1675H (L or R)	1643-1658	600	755	655	245	2080.56	2496.67
1700	GSC1700H (L or R)	1668-1683	600	755	655	270	2117.31	2540.77
1725	GSC1725H (L or R)	1693-1708	600	755	655	295	2172.31	2606.77
1750	GSC1750H (L or R)	1718-1733	600	755	655	320	2172.31	2606.77
1775	GSC1775H (L or R)	1743-1758	600	755	655	345	2172.31	2606.77
1800	GSC1800H (L or R)	1768-1783	600	755	655	370	2172.31	2606.77

This product is handed – please choose L for Left and R for Right when ordering.

Side Panel

Size	Code	Adjustment Min-Max	Price £ Exc. VAT	Price £ Inc. VAT
700	GMSSP700C	670-685	511.99	614.39
760	GMSSP760C	730-745	538.97	646.76
800	GMSSP800C	770-785	579.49	695.39
900	GMSSP900C	870-885	658.26	789.91
1000	GMSSP1000C	970-985	764.03	916.83

For wetroom / grout line adjustment please contact Customer Services.

Please Note: Images are for illustrative purposes only. Please refer to the installation guide when fitting the product.

Select Handle

Handle

	Price £ Exc. VAT	Price £ Inc. VAT
1. Standard Sliding Handle	-	-
2. Halo Handle	250.17	300.20



Select Halo Wall Profile

Halo Wall Profiles

	Price £ Exc. VAT	Price £ Inc. VAT
Fixed Panel Halo Profile	250.17	300.20
Side Panel Halo Profile	250.17	300.20

Select Door Handling



Please clearly outline any additions to your order.

Please Note: There is a minimum clearance of 100mm required above the shower enclosure to fix the top rail.



ALL THINGS ARE DESIGNED,
JUST SOME THINGS MORE
THOUGHTFULLY THAN OTHERS.



Arman Nobari



3 Panel Sliding Door with Side Panel shown as Left Hand (L)

1 DOOR QUADRANTS

FREE

MERLYN Wiper with each complete purchase of an Arysto Ten Product!



Features & Benefits

- Smooth flowing curves with crisp contemporary lines and frameless design details make this a true centrepiece for the bathroom.
- Ultra smooth rolling action and soft close door - Arysto AirGlyde Dual Track system ensures it effortlessly glides open and closed.
- Features such as Mersfield Stayclear easy clean glass and fully concealed fixings make this enclosure easy clean.



ARYSTO TEN

THE SLIDING DOOR COLLECTION

1 Door Quadrant

Size	Code	Adjustment Min-Max	Door Opening	Panel A Moving Panel	Panel B Fixed Panel	Panel C Fixed Panel	Price £ Exc. VAT	Price £ Inc. VAT
900	GSQ90H (L or R)	870-885	460	615	345	535	2294.13	2752.95
1000	GSQ10H (L or R)	970-985	460	615	445	635	2429.15	2914.98

This product is handed – please choose L for Left and R for Right when ordering.



1 Door Quadrant (R)

1 Door Offset Quadrant

Size	Code	Adjustment Min-Max	Door Opening	Panel A Moving Panel	Panel B Fixed Panel	Panel C Fixed Panel	Price £ Exc. VAT	Price £ Inc. VAT
1000 x 800	GSQ1080H (L or R)	970-985/ 770-785	460	615	445	485	2361.64	2833.97
1200 x 800	GSQ1280H (L or R)	1170-1185/ 770-785	460	615	645	485	2537.17	3044.61
1200 x 900	GSQ1290H (L or R)	1170-1185/ 870-885	460	615	645	535	2564.18	3077.02
1400 x 800	GSQ1480H (L or R)	1370-1385/ 770-785	460	615	845	485	2699.21	3239.05

This product is handed – please choose L for Left and R for Right when ordering.
For wetroom / grout line adjustment please contact Customer Services.

Select Handle

Handle

- Standard Sliding Handle



Select Halo Wall Profile

Halo Wall Profiles

	Price £ Exc. VAT	Price £ Inc. VAT
Fixed Panel Halo Profile*	250.17	300.20

*Must order 1 Profile for each side if required.

Select Door Handling

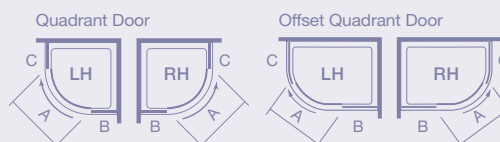

Please Note: Images are for illustrative purposes only. Please refer to the installation guide when fitting the product.

Please clearly outline any additions to your order.





GOOD DESIGN IS A LOT
LIKE CLEAR THINKING
MADE VISUAL.



Edward Tufte



1 Door Offset Quadrant shown as Right Hand (R)

ARYSTO TEN

THE HINGED DOOR COLLECTION

The ARYSTO TEN Hinged Collection is the ultimate in frameless design. Beautifully engineered hinges, designer and luxury 10mm glass makes this a true show stopper in any bathroom.

THE HINGED DOOR COLLECTION

A





Hinge Door & Inline Panel with Side Panel shown as Right Hand (R)

PENTANGLE

FREE

MERLYN Wiper with each complete purchase of an Arysto Ten Product!



Features & Benefits

- > The ultimate in frameless design with beautifully designed hinges and luxury 10mm glass this enclosure is a true show stopper.
- > Designer hinges highly engineered to ensure smooth and solid opening and closing.
- > Minimal framework and Mersfield Stayclear easy clean glass minimises cleaning time.
- > Supplied with a straight bracing bar to be positioned over the door.
- > Bespoke options available.



Product Information

Size	Code	Adjustment Min-Max	Door Opening	Panel A Moving Panel	Panel B Inline Panel	Panel C Hinged Panel	Price £ Exc. VAT	Price £ Inc. VAT
900 x 900	GHI9090H (L or R)	870-885/ 875-890	620	672	364	364	2159.32	2591.18
1200 x 900	GHI1290H (L or R)	1175-1185/ 870-885	620	672	665	364	2294.34	2753.21
1400 x 900	GHI1490H (L or R)	1370-1385/ 870-885	620	672	865	364	2342.75	2811.30

This product is handed – please choose L for Left and R for Right when ordering.

Please Note: Images are for illustrative purposes only. Please refer to the installation guide when fitting the product.



Pentangle Tray Features

- > Height 40mm.
- > Handcrafted from high grade stone resin.
- > Integrated discreet waste.
- > Luxurious matte textured finish.
- > Comes with 90mm fast flow waste.

Pentangle Tray

Pentangle Tray

Size	Code	Price £ Exc. VAT	Price £ Inc. VAT
900 x 900	T90PW	559.08	670.89
1200 x 900 (R)	T129PWR	623.80	748.56
1200 x 900 (L)	T129PWL	623.80	748.56
1400 x 900 (R)	T149PWR	660.59	792.70
1400 x 900 (L)	T149PWL	660.59	792.70

This product is handed – please choose L for Left and R for Right when ordering.

Select Handle

Handle

- Standard Hinge Handle
- Traditional Handle

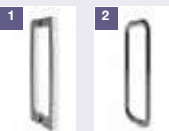

Select Door Handling (Pentangle)

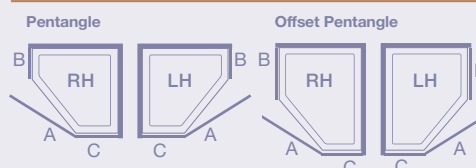

Select Door Handling (Pentangle Tray)



All products priced based on mirrored chrome finish. Please clearly outline any additions to your order.

//
LESS IS MORE

//
Ludwig Mies Van Der Rohe



Pentangle Door shown as Left Hand (L)

HINGE DOOR & INLINE PANEL IN RECESS

FREE

MERLYN Wiper with each complete purchase of an Arysto Ten Product!



Features & Benefits

- > The ultimate in frameless design with beautifully designed hinges and luxury 10mm glass this enclosure is a true show stopper.
- > Designer hinges highly engineered to ensure smooth and solid opening and closing.
- > Minimal framework and Mershield Stayclear easy clean glass minimises cleaning time.
- > Inline panel supplied with a straight/angled bracing bar.
- > Bespoke options available.



Product Information

Size	Code	Adjustment Min-Max	Door Opening	Panel A Moving Panel	Panel B Hinged Panel	Price £ Exc. VAT	Price £ Inc. VAT
900	GHA900H (L or R)	865-890	520	600	251	1548.32	1857.98
925	GHA925H (L or R)	890-915	545	625	251	1686.71	2024.06
950	GHA950H (L or R)	915-940	570	650	251	1686.71	2024.06
975	GHA975H (L or R)	940-965	595	675	251	1686.71	2024.06
1000	GHA1000H (L or R)	965-990	620	700	251	1686.71	2024.06
1025	GHA1025H (L or R)	990-1015	645	725	251	1720.49	2064.58
1050	GHA1050H (L or R)	1015-1040	670	750	251	1720.49	2064.58
1075	GHA1075H (L or R)	1040-1065	695	775	251	1720.49	2064.58
1100	GHA1100H (L or R)	1065-1090	620	700	351	1720.49	2064.58
1125	GHA1125H (L or R)	1090-1115	645	725	351	1784.62	2141.54
1150	GHA1150H (L or R)	1115-1140	670	750	351	1784.62	2141.54
1175	GHA1175H (L or R)	1140-1165	695	775	351	1784.62	2141.54
1200	GHA1200H (L or R)	1165-1190	620	700	451	1784.62	2141.54
1225	GHA1225H (L or R)	1190-1215	645	725	451	1864.51	2237.41
1250	GHA1250H (L or R)	1215-1240	670	750	451	1864.51	2237.41
1275	GHA1275H (L or R)	1240-1265	695	775	451	1864.51	2237.41
1300	GHA1300H (L or R)	1265-1290	720	800	451	1864.51	2237.41
1325	GHA1325H (L or R)	1290-1315	745	825	451	1883.70	2260.45
1350	GHA1350H (L or R)	1315-1340	770	850	451	1883.70	2260.45
1375	GHA1375H (L or R)	1340-1365	795	875	451	1883.70	2260.45
1400	GHA1400H (L or R)	1365-1390	720	800	551	1883.70	2260.45

This product is handed – please choose L for Left and R for Right when ordering.

Please Note: Images are for illustrative purposes only. Please refer to the installation guide when fitting the product.

Select Handle

Handle

- Standard Hinge Handle
- Traditional Handle

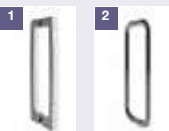

Select Door Handling



X: Door Opening



DESIGN IS NOT JUST WHAT
IT LOOKS LIKE. DESIGN IS
HOW IT WORKS.



Steve Jobs



Hinge Door & Inline Panel shown in Recess as Right Hand (R)

HINGE DOOR & 2 INLINE PANELS IN RECESS

FREE

MERLYN Wiper with each complete purchase of an Arysto Ten Product!



Features & Benefits

- > The ultimate in frameless design with beautifully designed hinges and luxury 10mm glass this enclosure is a true show stopper.
- > Designer hinges highly engineered to ensure smooth and solid opening and closing.
- > Minimal framework and Mershield Stayclear easy clean glass minimises cleaning time.
- > Inline Panel supplied with a straight/angled bracing bar.
- > Bespoke options available.



ARYSTO TEN

THE HINGED DOOR COLLECTION

Product Information

Size	Code	Adjustment Min-Max	Door Opening	Panel A Moving Panel	Panel B Hinged Panel	Panel C Inline Panel	Price £ Exc. VAT	Price £ Inc. VAT
1100	GHB1100H (L or R)	1060-1090	520	600	251	192	1881.44	2257.72
1125	GHB1125H (L or R)	1085-1115	545	625	251	192	1908.40	2290.08
1150	GHB1150H (L or R)	1110-1140	570	650	251	192	1908.40	2290.08
1175	GHB1175H (L or R)	1135-1165	595	675	251	192	1908.40	2290.08
1200	GHB1200H (L or R)	1160-1190	520	600	251	292	1908.40	2290.08
1225	GHB1225H (L or R)	1185-1215	545	625	251	292	1984.91	2381.90
1250	GHB1250H (L or R)	1210-1240	570	650	251	292	1984.91	2381.90
1275	GHB1275H (L or R)	1235-1265	595	675	251	292	1984.91	2381.90
1300	GHB1300H (L or R)	1260-1290	520	600	251	392	1984.91	2381.90
1325	GHB1325H (L or R)	1285-1315	545	625	251	392	2046.80	2456.16
1350	GHB1350H (L or R)	1310-1340	570	650	251	392	2046.80	2456.16
1375	GHB1375H (L or R)	1335-1365	595	675	251	392	2046.80	2456.16
1400	GHB1400H (L or R)	1360-1390	620	700	251	392	2046.80	2456.16
1425	GHB1425H (L or R)	1385-1415	645	725	251	392	2076.05	2491.26
1450	GHB1450H (L or R)	1410-1440	670	750	251	392	2076.05	2491.26
1475	GHB1475H (L or R)	1435-1465	695	775	251	392	2076.05	2491.26
1500	GHB1500H (L or R)	1460-1490	620	700	351	392	2076.05	2491.26
1525	GHB1525H (L or R)	1485-1515	645	725	351	392	2124.44	2549.33
1550	GHB1550H (L or R)	1510-1540	670	750	351	392	2124.44	2549.33
1575	GHB1575H (L or R)	1535-1565	695	775	351	392	2124.44	2549.33
1600	GHB1600H (L or R)	1560-1590	620	700	451	392	2124.44	2549.33
1625	GHB1625H (L or R)	1585-1615	645	725	451	392	2132.31	2558.77
1650	GHB1650H (L or R)	1610-1640	670	750	451	392	2132.31	2558.77
1675	GHB1675H (L or R)	1635-1665	695	775	451	392	2132.31	2558.77
1700	GHB1700H (L or R)	1660-1690	620	700	451	492	2132.31	2558.77
1725	GHB1725H (L or R)	1685-1715	645	725	451	492	2173.95	2608.74
1750	GHB1750H (L or R)	1710-1740	670	750	451	492	2173.95	2608.74
1775	GHB1775H (L or R)	1735-1765	695	775	451	492	2173.95	2608.74
1800	GHB1800H (L or R)	1760-1790	720	800	451	492	2173.95	2608.74
1825	GHB1825H (L or R)	1785-1815	745	825	451	492	2200.96	2641.16
1850	GHB1850H (L or R)	1810-1840	770	850	451	492	2200.96	2641.16
1875	GHB1875H (L or R)	1835-1865	795	875	451	492	2200.96	2641.16
1900	GHB1900H (L or R)	1860-1890	720	800	451	592	2200.96	2641.16

This product is handed – please choose L for Left and R for Right when ordering.

Select Handle

Handle

- Standard Hinge Handle
- Traditional Handle

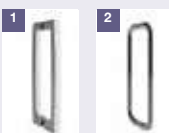

Please Note: Images are for illustrative purposes only. Please refer to the installation guide when fitting the product.

Select Door Handling

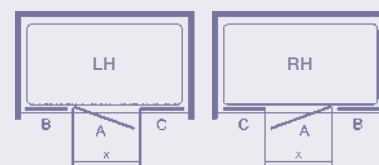

X: Door Opening

All products priced based on mirrored chrome finish. Please clearly outline any additions to your order.



//
FASHION FADES,
ONLY STYLE
REMAINS THE SAME.

//
Coco Chanel



Hinge Door & 2 Inline Panels in Recess shown as Right Hand (R)

HINGE DOOR & INLINE PANEL WITH SIDE PANEL

FREE

MERLYN Wiper with each complete purchase of an Arysto Ten Product!



Features & Benefits

- > The ultimate in frameless design with beautifully designed hinges and luxury 10mm glass this enclosure is a true show stopper.
- > Designer hinges highly engineered to ensure smooth and solid opening and closing.
- > Minimal framework and Mershield Stayclear easy clean glass minimises cleaning time.
- > Inline Panel supplied with a straight/angled bracing bar.
- > Bespoke options available.



Product Information

Size	Code	Adjustment Min-Max	Door Opening	Panel A Moving Panel	Panel B Hinged Panel	Price £ Exc. VAT	Price £ Inc. VAT
900	GHC900H (L or R)	865-880	565	600	226	1767.73	2121.28
1000	GHC1000H (L or R)	965-980	665	700	226	1797.00	2156.40
1100	GHC1100H (L or R)	1065-1080	665	700	326	1811.62	2173.95
1200	GHC1200H (L or R)	1165-1180	665	700	426	1827.39	2192.86
1300	GHC1300H (L or R)	1265-1280	765	800	426	1901.65	2281.98
1400	GHC1400H (L or R)	1365-1380	765	800	526	1929.76	2315.71

This product is handed – please choose L for Left and R for Right when ordering.

Side Panel

Size	Code	Adjustment Min-Max	Panel Size	Price £ Exc. VAT	Price £ Inc. VAT
700	GHSA700H	665-680	645	375.56	450.67
760	GHSA760H	725-740	705	385.96	463.15
800	GHSA800H	765-780	745	396.09	475.31
900	GHSA900H	865-880	845	418.58	502.30
1000	GHSA1000H	965-980	945	459.10	550.92

Side Panel is reversible.

Please Note: Images are for illustrative purposes only.

Please refer to the installation guide when fitting the product.

Select Handle

Handle

- Standard Hinge Handle
- Traditional Handle

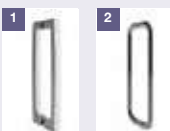

Select Door Handling

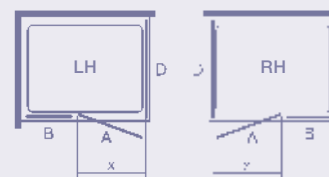

X: Door Opening



FORM FOLLOWS
FUNCTION.



Louis Sullivan



Hinge Door & Inline Panel with Side Panel shown as Left Hand (L)

HINGE DOOR & 2 INLINE PANELS WITH SIDE PANEL

FREE

MERLYN Wiper with each complete purchase of an Arysto Ten Product!



Features & Benefits

- > The ultimate in frameless design with beautifully designed hinges and luxury 10mm glass this enclosure is a true show stopper.
- > Designer hinges highly engineered to ensure smooth and solid opening and closing.
- > Minimal framework and Mershield Stayclear easy clean glass minimises cleaning time.
- > Inline Panel supplied with a straight/angled bracing bar.
- > Bespoke options available.



Product Information

Size	Code	Adjustment Min-Max	Door Opening	Panel A Moving Panel	Panel B Hinged Panel	Panel C Inline Panel	Price £ Exc. VAT	Price £ Inc. VAT
1100	GHD1100H (L or R)	1065-1080	520	600	251	182	2031.04	2437.25
1200	GHD1200H (L or R)	1165-1180	520	600	251	282	2063.68	2476.42
1300	GHD1300H (L or R)	1265-1280	520	600	251	382	2095.17	2514.21
1400	GHD1400H (L or R)	1365-1380	620	700	251	382	2164.95	2597.95
1500	GHD1500H (L or R)	1465-1480	620	700	351	382	2170.56	2604.67
1600	GHD1600H (L or R)	1565-1580	620	700	451	382	2223.46	2668.15
1700	GHD1700H (L or R)	1665-1680	620	700	451	482	2260.59	2712.71
1800	GHD1800H (L or R)	1765-1780	720	800	451	482	2301.10	2761.32
1900	GHD1900H (L or R)	1865-1880	720	800	451	582	2321.35	2785.62

This product is handed – please choose L for Left and R for Right when ordering.
Please Note: For wetroom / grout line adjustment please contact Customer Services.

Side Panel

Size	Code	Adjustment Min-Max	Panel Size	Price £ Exc. VAT	Price £ Inc. VAT
700	GHSB700H	665-680	635	375.56	450.67
760	GHSB760H	725-740	695	385.96	463.15
800	GHSB800H	765-780	735	396.09	475.31
900	GHSB900H	865-880	835	418.58	502.30
1000	GHSB1000H	965-980	935	459.10	550.92

Side Panel is reversible.
Please Note: Images are for illustrative purposes only. Please refer to the installation guide when fitting the product.

Select Handle

Handle

1. Standard Hinge Handle
2. Traditional Handle

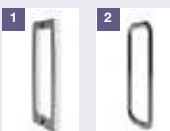

Select Door Handling

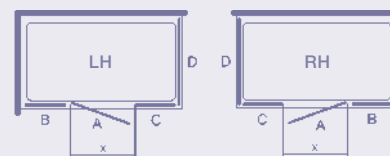

X: Door Opening

//
THE DETAILS ARE
NOT THE DETAILS.
THEY MAKE THE DESIGN.

//
Charles Eames



Hinge Door & 2 Inline Panels with Side Panel shown as Left Hand (L)

WALL HINGE DOOR IN RECESS

FREE

MERLYN Wiper with each complete purchase of an Arysto Ten Product!



Features & Benefits

- > The ultimate in frameless design with beautifully designed hinges and luxury 10mm glass this enclosure is a true show stopper.
- > Designer hinges highly engineered to ensure smooth and solid opening and closing.
- > Fully frameless enclosure with Mershield Stayclear easy clean glass minimises cleaning time.
- > Bespoke options available.



Product Information

Size	Code	Adjustment Min-Max	Door Opening	Panel Size	Price £ Exc. VAT	Price £ Inc. VAT
650	GHE650H	620-640	570	600	1205.14	1446.16
675	GHE675H	645-665	595	625	1205.14	1446.16
700	GHE700H	670-690	620	650	1205.14	1446.16
725	GHE725H	695-715	645	675	1252.38	1502.86
750	GHE750H	720-740	670	700	1252.38	1502.86
775	GHE775H	745-765	695	725	1252.38	1502.86
800	GHE800H	770-790	720	750	1252.38	1502.86
825	GHE825H	795-815	745	775	1282.77	1539.32
850	GHE850H	820-840	770	800	1282.77	1539.32
875	GHE875H	845-865	795	825	1282.77	1539.32
900	GHE900H	870-890	820	850	1282.77	1539.32

Please Note: All wall hinges must be secured to a reinforced/solid wall.
Reversible.

Please Note: Images are for illustrative purposes only. Please refer to the installation guide when fitting the product.

ARYSTO TEN

THE HINGED DOOR COLLECTION

Select Handle

Handle

1. Standard Hinge Handle
2. Traditional Handle

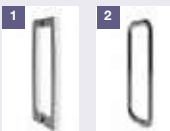

Select Door Handling

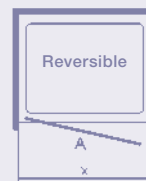

X: Door Opening

All products priced based on mirrored chrome finish. Please clearly outline any additions to your order.





ALL THINGS ARE DESIGNED,
JUST SOME THINGS MORE
THOUGHTFULLY THAN OTHERS.



Arman Nobari



Wall Hinge Door shown in Recess. (Reversible)

WALL HINGE DOOR WITH SIDE PANEL

FREE

MERLYN Wiper with each complete purchase of an Arysto Ten Product!



Features & Benefits

- > The ultimate in frameless design with beautifully designed hinges and luxury 10mm glass this enclosure is a true show stopper.
- > Designer hinges highly engineered to ensure smooth and solid opening and closing.
- > Minimal framework and Mershield Stayclear easy clean glass minimises cleaning time.
- > Side Panel supplied with an angled bracing bar.
- > Bespoke options available.



Product Information

Size	Code	Adjustment Min-Max	Door Opening	Panel Size	Price £ Exc. VAT	Price £ Inc. VAT
700	GHG700H (L or R)	670-680	620	625	1270.39	1524.47
800	GHG800H (L or R)	770-780	720	725	1278.26	1533.92
900	GHG900H (L or R)	870-880	820	825	1289.52	1547.43

This product is handed – please choose L for Left and R for Right when ordering

Please Note: All wall hinges must be secured to a reinforced/solid wall.

Side Panel

Size	Code	Adjustment Min-Max	Panel Size	Price £ Exc. VAT	Price £ Inc. VAT
700	GHSA700H	665-680	645	375.56	450.67
760	GHSA760H	725-740	705	385.96	463.15
800	GHSA800H	765-780	745	396.08	475.30
900	GHSA900H	865-880	845	418.58	502.30
1000	GHSA1000H	965-990	945	459.10	550.92

Reversible.

Please Note: Images are for illustrative purposes only. Please refer to the installation guide when fitting the product.

Please Note: For wetroom / grout line adjustment please contact Customer Services.

Select Handle

Handle

- Standard Hinge Handle
- Traditional Handle

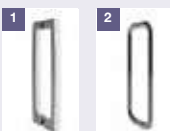

Select Door Handling

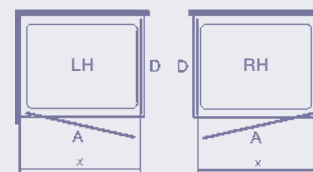

X: Door Opening

//
GOOD DESIGN IS
THOROUGH, DOWN
TO THE LAST DETAIL.

//
Dieter Rams



Wall Hinge Door with Side Panel shown as Left Hand (L)

WALL HINGE DOOR & INLINE PANEL IN RECESS

FREE

MERLYN Wiper with each complete purchase of an Arysto Ten Product!



Features & Benefits

- ▶ The ultimate in frameless design with beautifully designed hinges and luxury 10mm glass this enclosure is a true show stopper.
- ▶ Designer hinges highly engineered to ensure smooth and solid opening and closing.
- ▶ Minimal framework and Mershield Stayclear easy clean glass minimises cleaning time.
- ▶ Inline Panel supplied with a straight/angled bracing bar.
- ▶ Bespoke options available.



Product Information

Size	Code	Adjustment Min-Max	Door Opening	Panel A Moving Panel	Panel B Inline Panel	Price £ Exc. VAT	Price £ Inc. VAT
900	GHF900H (L or R)	865-890	620	650	196	1406.54	1687.84
925	GHF925H (L or R)	890-915	645	675	196	1479.68	1775.61
950	GHF950H (L or R)	915-940	670	700	196	1479.68	1775.61
975	GHF975H (L or R)	940-965	695	725	196	1479.68	1775.61
1000	GHF1000H (L or R)	965-990	720	750	196	1479.68	1775.61
1025	GHF1025H (L or R)	990-1015	745	775	196	1488.69	1786.42
1050	GHF1050H (L or R)	1015-1040	770	800	196	1488.69	1786.42
1075	GHF1075H (L or R)	1040-1065	795	825	196	1488.69	1786.42
1100	GHF1100H (L or R)	1065-1090	620	650	396	1488.69	1786.42
1125	GHF1125H (L or R)	1090-1115	645	675	396	1552.82	1863.38
1150	GHF1150H (L or R)	1115-1140	670	700	396	1552.82	1863.38
1175	GHF1175H (L or R)	1140-1165	695	725	396	1552.82	1863.38
1200	GHF1200H (L or R)	1165-1190	620	650	496	1552.82	1863.38
1225	GHF1225H (L or R)	1190-1215	645	675	496	1565.20	1878.24
1250	GHF1250H (L or R)	1215-1240	670	700	496	1565.20	1878.24
1275	GHF1275H (L or R)	1240-1265	695	725	496	1565.20	1878.24
1300	GHF1300H (L or R)	1265-1290	720	750	496	1565.20	1878.24
1325	GHF1325H (L or R)	1290-1315	745	775	496	1591.09	1909.31
1350	GHF1350H (L or R)	1315-1340	770	800	496	1591.09	1909.31
1375	GHF1375H (L or R)	1340-1365	795	825	496	1591.09	1909.31
1400	GHF1400H (L or R)	1365-1390	720	750	596	1591.09	1909.31
1425	GHF1425H (L or R)	1390-1415	745	775	596	1615.83	1939.00
1450	GHF1450H (L or R)	1415-1440	770	800	596	1615.83	1939.00
1475	GHF1475H (L or R)	1440-1465	795	825	596	1615.83	1939.00
1500	GHF1500H (L or R)	1465-1490	820	850	596	1615.83	1939.00

This product is handed – please choose L for Left and R for Right when ordering.

Please Note: All wall hinges **must** be secured to a **reinforced/solid wall**.

Select Handle

Handle

1. Standard Hinge Handle
2. Traditional Handle

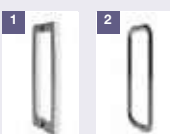

Please Note: Images are for illustrative purposes only. Please refer to the installation guide when fitting the product.

Select Door Handling

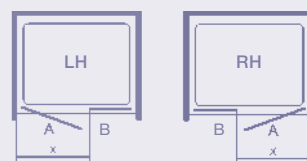

X: Door Opening

All products priced based on mirrored chrome finish. Please clearly outline any additions to your order.

//
GOOD DESIGN IS A LOT
LIKE CLEAR THINKING
MADE VISUAL.

//
Edward Tufte



Wall Hinge Door & Inline Panel in Recess shown as Left Hand (L)

WALL HINGE DOOR & INLINE PANEL WITH SIDE PANEL

FREE

MERLYN Wiper with each complete purchase of an Arysto Ten Product!



ARYSTO TEN

THE HINGED DOOR COLLECTION

Features & Benefits

- > The ultimate in frameless design with beautifully designed hinges and luxury 10mm glass this enclosure is a true show stopper.
- > Designer hinges highly engineered to ensure smooth and solid opening and closing.
- > Minimal framework and Mershield Stayclear easy clean glass minimises cleaning time.
- > Side Panel supplied with an angled bracing bar.
- > Bespoke options available.



Product Information

Size	Code	Adjustment Min-Max	Door Opening	Panel A Moving Panel	Panel B Inline Panel	Price £ Exc. VAT	Price £ Inc. VAT
900	GHH900H (L or R)	865-875	620	650	182	1544.94	1853.93
1000	GHH1000H (L or R)	965-975	620	650	282	1556.21	1867.45
1100	GHH1100H (L or R)	1065-1075	620	650	382	1566.33	1879.60
1200	GHH1200H (L or R)	1165-1175	620	650	482	1613.59	1936.30
1300	GHH1300H (L or R)	1265-1275	720	750	482	1627.09	1952.51
1400	GHH1400H (L or R)	1365-1375	720	750	582	1655.22	1986.27
1500	GHH1500H (L or R)	1465-1475	820	850	582	1741.86	2090.23

This product is handed – please choose L for Left and R for Right when ordering.

Please Note: All wall hinges must be secured to a reinforced/solid wall.

Please Note: For wetroom / grout line adjustment please contact Customer Services.

Please Note: Images are for illustrative purposes only. Please refer to the installation guide when fitting the product.

Side Panel

Size	Code	Adjustment Min-Max	Panel Size	Price £ Exc. VAT	Price £ Inc. VAT
700	GHSB700H	665-680	635	375.56	450.67
760	GHSB760H	725-740	695	385.96	463.15
800	GHSB800H	765-780	735	396.09	475.31
900	GHSB900H	865-880	835	418.58	502.30
1000	GHSB1000H	965-980	935	459.10	550.92

Side Panel is reversible.

Select Handle

Handle

- Standard Hinge Handle
- Traditional Handle

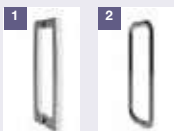

Select Door Handling

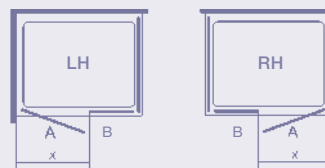

X: Door Opening

All products priced based on mirrored chrome finish. Please clearly outline any additions to your order.



//
LESS IS MORE

//
Ludwig Mies Van Der Rohe



Wall Hinge Door & Inline Panel with Side Panel shown as Left Hand (L)

ARYSTO
TEN

THE WETROOM COLLECTION

Whether you are after a New York style loft or you need to create a bathroom with inclusive design, then Wetrooms are the solution for you. Suitable for both corner installation, with or without end panels, or in an alcove / recess.





Double Entry Shower Panel

WETROOM PANEL WITH OR WITHOUT END PANEL

FREE

MERLYN Wiper with each complete purchase of an Arysto Ten Product!



Features & Benefits

- > The definition of modern showering - the simple shower panel stands at 2015mm high, including rail and provides an easy walk-through, making you feel instantly refreshed.
- > Bespoke options available.
- > Frameless glass and Mershield Stayclear easy clean glass minimises cleaning time.
- > All panels over 1100mm and over are supplied with a 1M straight bracing bar.



Product Information

Size	Code	Adjustment Min-Max	Price £ Exc. VAT	Price £ Inc. VAT
400	GWA400	375-390	661.64	793.97
600	GWA600	575-590	688.64	826.37
700	GWA700	675-690	702.14	842.57
800	GWA800	775-790	702.14	842.57
900	GWA900	875-890	735.49	882.59
1000	GWA1000	975-990	765.15	918.18
1100	GWA1100	1075-1090	823.67	988.41
1200	GWA1200	1175-1190	864.18	1037.01
1300	GWA1300	1275-1290	897.95	1077.54
1400	GWA1400	1375-1390	938.46	1126.15
1500	GWA1500	1475-1490	965.47	1158.56
1600	GWA1600	1575-1590	992.48	1190.97

Please Note: All panels 1100mm and over come with a 1000mm straight stabilising bar.

End Panel

Size	Code	Adjustment Min-Max	Price £ Exc. VAT	Price £ Inc. VAT
400	GWA400	375-390	661.64	793.97
600	GWA600	575-590	688.64	826.37
700	GWA700	675-690	702.14	842.57
800	GWA800	775-790	702.14	842.57
900	GWA900	875-890	735.49	882.59
1000	GWA1000	975-990	765.15	918.18

Note: Minimum opening we recommend is 500mm.

Technical Drawing

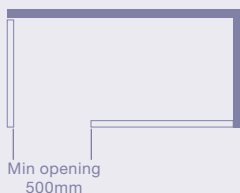

Please Note: Images are for illustrative purposes only. Please refer to the installation guide when fitting the product.

All products priced based on mirrored chrome finish. Please clearly outline any additions to your order.

//
FORM FOLLOWS
FUNCTION.

//
Louis Sullivan



Shower Panel shown with End Panel

WETROOM PANEL & HINGED PANEL WITH OR WITHOUT END PANEL

FREE

MERLYN Wiper with each complete purchase of an Arysto Ten Product!



Features & Benefits

- > The Wetroom Panel and Hinged panel is designed to gently reflect water into your showering area and give added protection against splashes.
- > Bespoke options available.
- > Frameless glass and Mershield Stayclear easy clean glass minimises cleaning time.
- > All panels over 1100mm and over are supplied with a 1M straight bracing bar.



Product Information

Size	Code	Adjustment Min-Max	Shower Panel	Hinge Panel	Price £ Exc. VAT	Price £ Inc. VAT
1000	GWE1000	675-690	673	300	1309.78	1571.73
1100	GWE1100	775-790	773	300	1336.79	1604.14
1200	GWE1200	875-890	873	300	1343.54	1612.25
1300	GWE1300	975-990	973	300	1477.43	1772.91
1500	GWE1500	1175-1190	1173	300	1747.49	2096.99

Please Note: All panels 1100mm and over come with a 1000mm straight stabilising bar.

Please Note: Images are for illustrative purposes only. Please refer to the installation guide when fitting the product.

Please Note: Product is 2015mm high including stabilising bar.

End Panel

Size	Code	Adjustment Min-Max	Price £ Exc. VAT	Price £ Inc. VAT
400	GWA400	375-390	661.64	793.97
600	GWA600	575-590	688.64	826.37
700	GWA700	675-690	702.14	842.57
800	GWA800	775-790	702.14	842.57
900	GWA900	875-890	735.49	882.59
1000	GWA1000	975-990	765.15	918.18

Note: Minimum opening we recommend is 500mm.

Technical Drawing

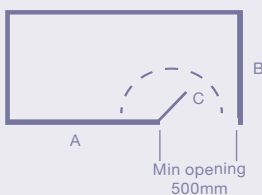



ALL THINGS ARE DESIGNED,
JUST SOME THINGS MORE
THOUGHTFULLY THAN OTHERS.



Arman Nobari



Shower Panel and Hinged Swivel Panel shown with End Panel

WETROOM PANEL WITH DOUBLE ENTRY

FREE

MERLYN Wiper with each complete purchase of an Arysto Ten Product!



Features & Benefits

- > The definition of modern showering - the simple shower panel stands at 2015mm high, including rail and provides an easy walk-through, making you feel instantly refreshed.
- > Bespoke options available.
- > Frameless glass and Mershield Stayclear easy clean glass minimises cleaning time.
- > Supplied with two 1000mm straight bracing bars.



Product Information

Size	Code	Glass Width	Price £ Exc. VAT	Price £ Inc. VAT
1400	GWF1400	1380	1046.49	1255.78
1600	GWF1600	1580	1073.49	1288.19

Supplied with two straight 1000mm bracing bars.

Please Note: Images are for illustrative purposes only. Please refer to the installation guide when fitting the product.

Technical Drawing



//
SIMPLICITY IS THE
ULTIMATE FORM OF
SOPHISTICATION.

//
Leonardo Da Vinci



Double Entry Shower Panel

ARYSTO TEN

THE BESPOKE COLLECTION

THE BESPOKE COLLECTION

The Arysto Bespoke Collection has everything you need to create that unique showering experience. Whether your preference is for an ultra modern wetroom or something more unique for your attic conversion. The Bespoke Collection allows you to tailor any of our already stunning enclosures/wetroom panels to create a truly unique enclosure for your bathroom.

Choose from an array of options such as 4 glazing finishes, UV Bonding, increased heights and widths and the ability to cut to almost any shape or size to fit any awkward spaces, creating that perfect showering experience in your home. Factor in the reliable survey and installation services as well as the Lifetime Guarantee and you've got added peace of mind.

CHROME OPTION AVAILABLE ONLY.





Bespoke Hinge Door with 2 Inline Panels shown with increased height, notch cuts and angle cuts



BESPOKE HINGE DOOR WITH INLINE PANEL

Shown with increased height and smoked black glass.



BESPOKE (3 PANEL) SLIDING DOOR

Shown with dwarf wall and notch cut.



BESPOKE WALL HINGE WITH INLINE PANEL

Shown with dwarf wall and notch cut.



BESPOKE WALK IN

Shown with increased height, notch and angle cut and 2 towel rails.

BESPOKE OPTIONS

FREE
 MERLYN Wiper with each complete purchase of an Arysto Ten Product!



Here is a brief guide to the services and options available through our Bespoke Collection. We can tailor any enclosure from our Arysto Collection to suit your unique requirements.

Glazing Options



Ultra Clear Standard Clear Satin Smoked Black

Colour Finish Options



Mirrored Chrome

Size Options

MERLYN can tailor your shower enclosure to fit any space, with size options of up to **2400mm** in both width and height.

Handle



Halo Handle

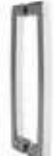

Standard Hinge Handle



Traditional Handle



Standard Sliding Handle



Slim Handle



Eyelet Handle

Notch Cut, Angle Cut and Dwarf Walls

With these options you can fit your shower enclosure to any space.



Angle Cut



Dwarf Walls



Notch Cut

UV Bonding

UV technology gives you an optically clear, strong perfect bond.

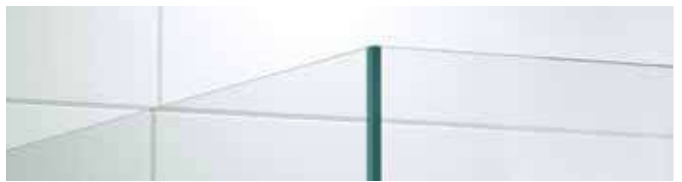

UV Bonding (Two pieces of glass bonded together).

Stabilising Bar



Angled Stabilising Bar



Straight Stabilising Bar



T-Bar



Ceiling Brackets

Wall and Floor



Standard Floor Profile



Recessed Floor Profile



Standard Wall Profile



Recessed Wall Profile

Accessories



Seat



Standard Towel Rail



Traditional Towel Rail



Shelf

Installation and Survey Service



MERLYN Arysto offer a Survey and Installation Service as we understand that creating your dream showering enclosure can be difficult, especially if dealing with awkward spaces. We have a team of highly skilled and experienced professionals who are trained to survey for varying slopes and angles, look for 'out of true' walls and assess that your choice of enclosure is suitable. Prices available upon request.
Please note: The tray or wetroom floor must be installed and walls finished/tiled before any site survey can be done.



ARYSTO EIGHT

The Red Dot award winning ARYSTO EIGHT range elevates any space it occupies. Subtle design detailing has been used to enhance the virtually frameless quality of the range. The chamfered edges of the ultra slim frame reflect ambient light reducing the visual impact of the enclosures.

Every detail has been very carefully designed within this range - many of the standard design features have been redeveloped to ensure we maintained the integrity of the design and aesthetic we set out to achieve.



reddot design award
winner 2018





Infold Door with Inline Panel and Side Panel show as Left Hand (L)

SLIDING DOOR WITH SIDE PANEL

Features & Benefits

- > Virtually frameless - ultra slim profiles and subtle design detailing enhances the quality of this enclosure.
- > Ultra smooth rolling action ensures this door effortlessly glides open and closed.
- > Easy clean with Mershiel Stayclear easy clean glass, **revolutionary self cleaning rollers*** and fully concealed fixings minimises cleaning time.
- > Soft close door - a natural but solid closing door with no bounce back on closing.



Product Information

Size	Code	Adjustment Min-Max	Price £ Exc. VAT	Price £ Inc. VAT
1000	AR8SL100SP	970-990	1045.90	1255.08
1100	AR8SL110SP	1070-1090	1045.90	1255.08
1200	AR8SL120SP	1170-1190	1045.90	1255.08
1300	AR8SL130SP	1270-1290	1316.92	1580.31
1400	AR8SL140SP	1370-1390	1316.92	1580.31
1500	AR8SL150SP	1470-1490	1353.87	1624.65
1600	AR8SL160SP	1570-1590	1390.84	1669.00
1700	AR8SL170SP	1670-1690	1452.43	1742.92

Reversible.

Side Panel – for use with Sliding Door only

Size	Code	Adjustment Min-Max	Price £ Exc. VAT	Price £ Inc. VAT
700	AR8SPSL70	670-690	553.13	663.76
760	AR8SPSL76	730-750	553.13	663.76
800	AR8SPSL80	770-790	553.13	663.76
900	AR8SPSL90	870-890	590.09	708.11
1000	AR8SPSL100	970-990	651.69	782.03

Reversible.

Please Note: The door must close against the Side Panel.

Please Note: Images are for illustrative purposes only. Please refer to the installation guide when fitting the product.

Technical Drawing

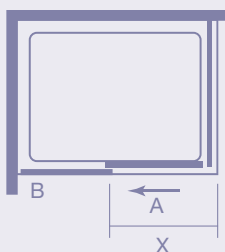

Size	Door Opening X	Panel A Moving Panel	Panel B Fixed Panel
1000	384	516	428
1100	434	566	478
1200	484	616	528
1300	534	667	626
1400	584	716	628
1500	584	716	728
1600	584	716	828
1700	584	716	928

A: Moving Panel

B: Fixed Panel

X: Door Opening

Extension profiles available. See Page 107.

//
LESS IS MORE

//
Ludwig Mies Van Der Rohe



Sliding Door shown with Side Panel

SLIDING DOOR IN RECESS

Features & Benefits

- › Virtually frameless - ultra slim profiles and subtle design detailing enhances the quality of this enclosure.
- › Ultra smooth rolling action ensures this door effortlessly glides open and closed.
- › Easy clean with Mershiel Stayclear easy clean glass, **revolutionary self cleaning rollers*** and fully concealed fixings minimises cleaning time.
- › Soft close door - a natural but solid closing door with no bounce back on closing.



Product Information

Size	Code	Adjustment Min-Max	Price £ Exc. VAT	Price £ Inc. VAT
1000	AR8SL100REC	950-990	1045.90	1255.08
1100	AR8SL110REC	1050-1090	1045.90	1255.08
1200	AR8SL120REC	1150-1190	1045.90	1255.08
1300	AR8SL130REC	1250-1290	1316.92	1580.31
1400	AR8SL140REC	1350-1390	1316.92	1580.31
1500	AR8SL150REC	1450-1490	1353.87	1624.65
1600	AR8SL160REC	1550-1590	1390.84	1669.00
1700	AR8SL170REC	1650-1690	1452.43	1742.92

Reversible.

Please Note: Images are for illustrative purposes only. Please refer to the installation guide when fitting the product.

Technical Drawing

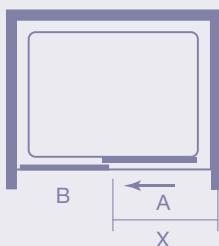

Size	Door Opening X	Panel A Moving Panel	Panel B Fixed Panel
1000	365-385	516	428
1100	415-435	566	478
1200	470-490	616	528
1300	465-485	667	626
1400	515-535	716	628
1500	565-585	716	728
1600	565-585	716	828
1700	565-585	716	928

A: Moving Panel
B: Fixed Panel
X: Door Opening

Extension profiles available. See Page 107.



THE DETAILS ARE
NOT THE DETAILS.
THEY MAKE THE DESIGN



Charles Eames



Sliding Door shown in Recess (Reversible)

INFOLD DOOR IN RECESS

Features & Benefits

- Space saving solution - perfect for bathrooms tight on space, this door opens inwards minimising the outward opening space required.
- Easy clean with Mershield Stayclear easy clean glass and fully concealed fixings minimises cleaning time.
- Virtually frameless - ultra slim profiles and subtle design details enhance the frameless quality of this enclosure.
- Ultra smooth opening action ensures this door effortlessly glides open and closed.



Product Information

Size	Code	Adjustment Min-Max	Price £ Exc. VAT	Price £ Inc. VAT
700	AR8NF70 (L or R)	650-690	984.29	1181.15
760	AR8NF76 (L or R)	710-750	984.29	1181.15
800	AR8NF80 (L or R)	750-790	984.29	1181.15
900	AR8NF90 (L or R)	850-890	996.61	1195.93
1000	AR8NF100 (L or R)	950-990	1070.54	1284.64

This product is handed - please choose L for Left and R for Right when ordering.

Please Note: Images are for illustrative purposes only. Please refer to the installation guide when fitting the product.

Technical Drawing

Door Open

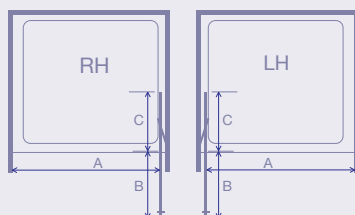

Size	Door Opening A	Outside Door Swing B	Inside Door Swing C
700	440-460	211	420
760	500-520	271	420
800	540-560	311	420
900	640-660	411	420
1000	740-760	511	420

A: Door Opening
B: Outside Door Swing
C: Inside Door Swing

Extension profiles available. See Page 107.
*Patented



SIMPLICITY IS THE
ULTIMATE FORM OF
SOPHISTICATION.



Leonardo Da Vinci



reddot design award
winner 2018

Infold Door in Recess shown as Left Hand (L)

INFOLD DOOR WITH SIDE PANEL

Features & Benefits

- > Space saving solution - perfect for bathrooms tight on space, this door opens inwards minimising the outward opening space required.
- > Easy clean with Mershield Stayclear easy clean glass and fully concealed fixings minimises cleaning time.
- > Virtually frameless - ultra slim profiles and subtle design details enhance the frameless quality of this enclosure.
- > Ultra smooth opening action ensures this door effortlessly glides open and closed.



Product Information

Size	Code	Adjustment Min-Max	Price £ Exc. VAT	Price £ Inc. VAT
700	AR8NF70 (L or R)	655-675	984.29	1181.15
760	AR8NF76 (L or R)	715-735	984.29	1181.15
800	AR8NF80 (L or R)	755-775	984.29	1181.15
900	AR8NF90 (L or R)	855-875	996.61	1195.93
1000	AR8NF100 (L or R)	955-975	1070.54	1284.64

This product is handed – please choose L for Left and R for Right when ordering.

Please Note: The door must close against the Side Panel

Side Panel – for use with Infold Door only

Size	Code	Adjustment Min-Max	Price £ Exc. VAT	Price £ Inc. VAT
700	AR8SP70NF	670-690	553.13	663.76
760	AR8SP76NF	730-750	553.13	663.76
800	AR8SP80NF	770-790	553.13	663.76
900	AR8SP90NF	870-890	590.09	708.11
1000	AR8SP100NF	970-990	651.69	782.03
1200	AR8SP120NF	1170-1190	737.92	885.50

Reversible.

Please Note: Images are for illustrative purposes only. Please refer to the installation guide when fitting the product.

Technical Drawing

Door Open

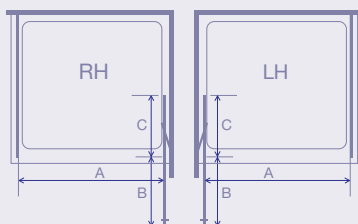

Size	Door Opening A	Outside Door Swing B	Inside Door Swing C
700	460	211	420
760	520	271	420
800	560	311	420
900	660	411	420
1000	760	511	420

A: Door Opening

B: Outside Door Swing

C: Inside Door Swing

Extension profiles available. See Page 107.

Please Note: The door must close against the Side Panel

*Patented

//
FASHION FADES,
ONLY STYLE
REMAINS THE SAME.

//
Coco Chanel



reddot design award
winner 2018

INFOLD DOOR WITH INLINE PANEL



We have carefully considered every little detail of the Arysto Collection. The unique design developed for the range features smooth flowing curves, punctuated by crisp contemporary lines and a subtle 'Frameless' finish.

Features & Benefits Features

- > Space saving solution - perfect for bathrooms tight on space, this door opens inwards minimising the outward opening space required.
- > Easy clean with Mershield Stayclear easy clean glass and fully concealed fixings minimises cleaning time.
- > Virtually frameless - ultra slim profiles and subtle design details enhance the frameless quality of this enclosure.
- > Ultra smooth opening action ensures this door effortlessly glides open and closed.

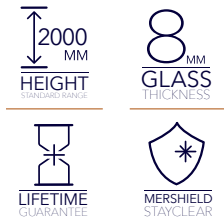

Product Information

Size	Code	Adjustment with Side Panel Min-Max	Adjustment in Recess Min-Max	Door Size	Inline Size	Price £ Exc. VAT	Price £ Inc. VAT
900	AR8NN9002H (LorR)	860-880	860-900	700	210	1345.43	1614.51
960	AR8NN9602H (LorR)	920-940	920-960	760	210	1345.43	1614.51
1000	AR8NN1002H (LorR)	960-980	960-1000	800	210	1345.43	1614.51
1100	AR8NN1104H (LorR)	1060-1080	1060-1100	700	410	1405.81	1686.98
1160	AR8NN1164H (LorR)	1120-1140	1120-1160	760	410	1405.81	1686.98
1200	AR8NN1204H (LorR)	1160-1180	1160-1200	800	410	1405.81	1686.98
1300	AR8NN1306H (LorR)	1260-1280	1260-1300	700	610	1466.20	1759.44
1360	AR8NN1366H (LorR)	1320-1340	1320-1360	760	610	1466.20	1759.44
1400	AR8NN1406H (LorR)	1360-1380	1360-1400	800	610	1466.20	1759.44
1500	AR8NN1506H (LorR)	1460-1480	1460-1500	900	610	1478.31	1773.97
1600	AR8NN1606H (LorR)	1560-1580	1560-1600	1000	610	1551.96	1862.35

Please Note: Images are for illustrative purposes only. Please refer to the installation guide when fitting the product. This product is handed – please choose L for Left and R for Right when ordering. Please Note: The door must close against the Inline Panel.

Infold Side Panel

Size	Code	Adjustment Min-Max	Price £ Exc. VAT	Price £ Inc. VAT
700	AR8SPN70H	655-675	597.78	717.33
760	AR8SPN76H	715-735	597.78	717.33
800	AR8SPN80H	755-775	597.78	717.33
900	AR8SPN90H	855-875	634.74	761.69
1000	AR8SPN100H	955-975	696.34	835.60
1200	AR8SPN120H	1155-1175	782.57	939.08

Technical Drawing

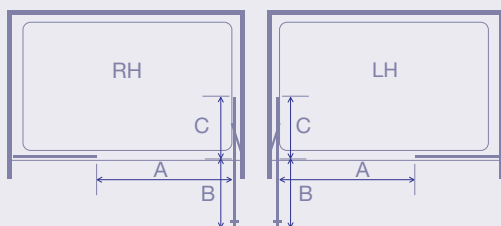

A: Door Opening
B: Outside Door Swing
C: Inside Door Swing

Size	Door Opening A	Outside Door Swing B	Inside Door Swing C
900	480	211	420
960	540	271	420
1000	580	311	420
1100	480	211	420
1160	540	271	420
1200	580	311	420
1300	480	211	420
1360	540	271	420
1400	580	311	420
1500	680	411	420
1600	780	511	420

Extension profiles available. See Page 107. Please Note: The door must close against the Side Panel *Patented





THE FUNCTION OF
DESIGN IS LETTING
DESIGN FUNCTION



Micha Commeren



1 DOOR QUADRANT

Features & Benefits

- > Virtually frameless - ultra slim profiles and subtle design detailing enhances the quality of this enclosure.
- > Ultra smooth rolling action ensures this door effortlessly glides open and closed.
- > Easy clean with Mershield Stayclear easy clean glass, **revolutionary self cleaning rollers*** and fully concealed fixings minimises cleaning time.
- > Soft close door - a natural but solid closing door with no bounce back on closing.



Product Information

Size	Code	Adjustment Min-Max	Price £ Exc. VAT	Price £ Inc. VAT
800 x 800	AR81Q800 (L or R)	770-790	1230.68	1476.82
900 x 900	AR81Q900 (L or R)	870-890	1230.68	1476.82
1000 x 1000	AR81Q1000 (L or R)	970-990	1353.87	1624.65

Please Note: Images are for illustrative purposes only. Please refer to the installation guide when fitting the product.

This product is handed – please choose L for Left and R for Right when ordering.

Technical Drawing

Quadrant Door

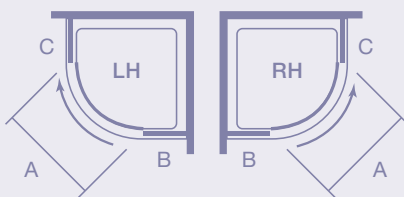

Size	Door Opening A	Flat Fixed Panel B	Curved Fixed Panel C
800	430	210	510
900	470	310	570
1000	470	410	670

A: Door Opening
B: Fixed Panel
C: Curved Fixed Panel

//
FORM FOLLOWS
FUNCTION.

//
Louis Sullivan



1 Door Quadrant shown as Left Hand (L)

1 DOOR OFFSET QUADRANT

Features & Benefits

- > Virtually frameless - ultra slim profiles and subtle design detailing enhances the quality of this enclosure.
- > Ultra smooth rolling action ensures this door effortlessly glides open and closed.
- > Easy clean with Mershield Stayclear easy clean glass, **revolutionary self cleaning rollers*** and fully concealed fixings minimises cleaning time.
- > Soft close door - a natural but solid closing door with no bounce back on closing.



Product Information

Size	Code	Adjustment Min-Max	Price £ Exc. VAT	Price £ Inc. VAT
900 x 760	AR81Q976 (L or R)	870-890 / 730-750	1415.48	1698.58
1000 x 800	AR81Q1080 (L or R)	970-990 / 770-790	1415.48	1698.58
1200 x 800	AR81Q1280 (L or R)	1170-1190 / 770-790	1415.48	1698.58
1200 x 900	AR81Q1290 (L or R)	1170-1190 / 870-890	1415.48	1698.58
1400 x 800	AR81Q1480 (L or R)	1370-1390 / 770-790	1477.07	1772.48

This product is handed – please choose L for Left and R for Right when ordering.

Please Note: Images are for illustrative purposes only. Please refer to the installation guide when fitting the product.

Technical Drawing

Offset Quadrant Door

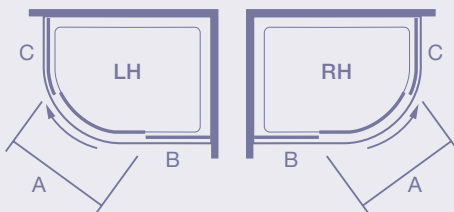

Size	Door Opening A	Fixed Panel B	Curved Fixed Panel C
900 x 760	415	310	490
1000 x 800	430	410	510
1200 x 800	430	610	510
1200 x 900	470	610	570
1400 x 800	430	810	510

A: Door Opening
B: Fixed Panel
C: Curved Fixed Panel

*Patent Pending

//
GOOD DESIGN IS A LOT
LIKE CLEAR THINKING
MADE VISUAL.

//
Edward Tufte



1 Door Offset Quadrant shown as Left Hand (L)

↑
1950
MM
↓
HEIGHT
STANDARD RANGE

6^{MM}
GLASS
THICKNESS

LIFETIME
GUARANTEE

MERSHIELD
STAYCLEAR

ARYSTO SIX

This range is a unique designer 6mm semi-frameless product that brings a minimal, sophisticated style to the bathroom. The signature glass cut-away creates a floating appearance that has been crafted to amplify and accentuate the lightness of design, without compromising the performance of the product. The ARYSTO SIX stands out from the crowd making a statement in any bathroom.





Sliding Door in Recess

SLIDING DOOR

Features & Benefits

- › Precise, clean lines and slim profile edges contrasted by our signature glass cut-out, creates a crisp minimal enclosure.
- › Designer solid chrome handle gives additional weight and solid feeling to the door.
- › Easy to clean enclosure with features such as Mersfield Stayclear and fully concealed fixings making this enclosure as easy to clean as they come.
- › Soft close rollers that effortlessly glide to an extra smooth close.



Product Information (Table codes for both the recess and side panel doors)

Size	Code	Adjustment in Recess Min-Max	Adjustment with Side Panel Min-Max	Price £ Exc. VAT	Price £ Inc. VAT
1000	AR6SL100REC	940-990	958-1008	571.26	685.51
1100	AR6SL110REC	1040-1090	1058-1108	571.26	685.51
1200	AR6SL120REC	1140-1190	1158-1208	571.26	685.51
1300	AR6SL130REC	1240-1290	1258-1308	651.39	781.67
1400	AR6SL140REC	1340-1390	1358-1408	708.63	850.36
1500	AR6SL150REC	1440-1490	1458-1508	742.98	891.57

Reversible.

Please Note: Images are for illustrative purposes only. Please refer to the installation guide when fitting the product.

Side Panel

Size	Code	Adjustment Min-Max	Price £ Exc. VAT	Price £ Inc. VAT
760	AR6SP76	725-750	285.06	342.07
800	AR6SP80	765-790	285.06	342.07
900	AR6SP90	865-890	307.95	369.54

Reversible.

Technical Drawing

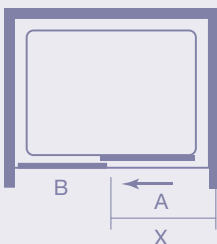

Size	Door Opening	Panel A Moving Panel	Panel B Fixed Panel
1000	372	482	403
1100	422	532	453
1200	472	582	503
1300	522	632	553
1400	572	682	603
1500	572	682	703

A: Moving Panel
B: Fixed Panel
X: Door Opening

Extension profiles available. See Page 107.

//
FORM FOLLOWS
FUNCTION.

//
Louis Sullivan



Sliding Door in Recess

PIVOT DOOR

Features & Benefits

- › Precise, clean lines and slim profile edges contrasted by our signature glass cut-out, creates a crisp minimal enclosure.
- › Designer solid chrome handle gives additional weight and solid feeling to the door.
- › Easy to clean enclosure with features such as Mersfield Stayclear and fully concealed fixings making this enclosure as easy to clean as they come.
- › Solid “Clunk” close.



Product Information

Size	Code	Adjustment in Recess Min-Max	Adjustment with Side Panel Min-Max	Price £ Exc. VAT	Price £ Inc. VAT
760	AR6PV76	700-750	718-768	468.22	561.87
800	AR6PV80	740-790	758-808	468.22	561.87
900	AR6PV90	840-890	858-908	491.12	589.34

Reversible.

Please Note: The door must close against the Side Panel

Please Note: Images are for illustrative purposes only. Please refer to the installation guide when fitting the product.

Side Panel

Size	Code	Adjustment Min-Max	Price £ Exc. VAT	Price £ Inc. VAT
760	AR6SP76	725-750	285.06	342.07
800	AR6SP80	765-790	285.06	342.07
900	AR6SP90	865-890	307.95	369.54

Reversible.

Inline Panel

Size	Code	Adjustment Min-Max	Price £ Exc. VAT	Price £ Inc. VAT
150	AR6IN150	125-150	250.71	300.85
210	AR6IN210	185-210	273.61	328.33

Please Note: The Inline Panel should only be used on the hinged side and not the closing side of the enclosure.

Technical Drawing

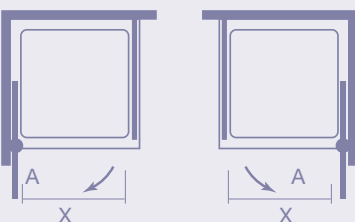

Size	Door Opening	Moving Panel	Door Swing A
760	483	614	470
800	523	654	510
900	623	754	610

X: Door Opening
A: Door Swing

Extension profiles available. See Page 107.

//
LESS IS MORE

//
Ludwig Mies Van Der Rohe



Pivot Door with Side Panel

INFOLD DOOR

Features & Benefits

- Precise, clean lines and slim profile edges contrasted by our signature glass cut-out, creates a crisp minimal enclosure.
- Designer solid chrome handle gives additional weight and solid feeling to the door.
- Easy clean enclosure with Mershield Stayclear and fully concealed fixings minimising cleaning time.
- Space saving solution - perfect for bathrooms tight on space, this door opens inwards minimising the outward opening space required.



Product Information

Size	Code	Adjustment in Recess Min-Max	Adjustment with Side Panel Min-Max	Price £ Exc. VAT	Price £ Inc. VAT
760	AR6NF76 (L or R)	700-750	718-768	651.39	781.67
800	AR6NF80 (L or R)	740-790	758-808	651.39	781.67
900	AR6NF90 (L or R)	840-890	858-908	651.39	781.67

Please Note: Images are for illustrative purposes only. Please refer to the installation guide when fitting the product. This product is handed – please choose L for Left and R for Right when ordering.

Side Panel

Size	Code	Adjustment Min-Max	Price £ Exc. VAT	Price £ Inc. VAT
760	AR6SP76	725-750	285.06	342.07
800	AR6SP80	765-790	285.06	342.07
900	AR6SP90	865-890	307.95	369.54

Reversible.

Inline Panel

Size	Code	Adjustment Min-Max	Price £ Exc. VAT	Price £ Inc. VAT
150	AR6IN150	125-150	250.71	300.85
210	AR6IN210	185-210	273.61	328.33



Infold Door with Inline Panel and Side Panel shown as Left Hand (L)

Technical Drawing

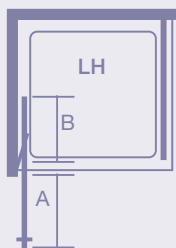

Size	Door Opening	Moving Panel	Outside Door Swing A	Inside Door Swing B
760	539	614	270	345
800	579	654	310	345
900	679	754	410	345

A: Outside Door Swing
B: Inside Door Swing

Extension profiles available. See Page 107.



GOOD DESIGN IS A LOT
LIKE CLEAR THINKING
MADE VISUAL.



Edward Tufte



Infold Door with Side Panel shown as Left Hand (L)

BIFOLD DOOR

Features & Benefits

- › Precise, clean lines and slim profile edges contrasted by our signature glass cut-out, creates a crisp minimal enclosure.
- › Designer solid chrome handle gives additional weight and solid feeling to the door.
- › Easy clean enclosure with Mersfield Stayclear and fully concealed fixings minimising cleaning time.
- › Space saving solution - perfect for bathrooms tight on space, this door opens inwards with no outward opening space required.



Product Information

Size	Code	Adjustment in Recess Min-Max	Adjustment with Side Panel Min-Max	Price £ Exc. VAT	Price £ Inc. VAT
760	AR6BF76 (L or R)	700-750	718-768	651.39	781.67
800	AR6BF80 (L or R)	740-790	758-808	651.39	781.67
900	AR6BF90 (L or R)	840-890	858-908	651.39	781.67
1000	AR6BF100 (L or R)	940-990	958-1008	651.39	781.67

This product is handed – please choose L for Left and R for Right when ordering.

Please Note: Images are for illustrative purposes only. Please refer to the installation guide when fitting the product.

Side Panel

Size	Code	Adjustment Min-Max	Price £ Exc. VAT	Price £ Inc. VAT
760	AR6SP76	725-750	285.06	342.07
800	AR6SP80	765-790	285.06	342.07
900	AR6SP90	865-890	307.95	369.54

Reversible.

Inline Panel

Size	Code	Adjustment Min-Max	Price £ Exc. VAT	Price £ Inc. VAT
150	AR6IN150	125-150	250.71	300.85
210	AR6IN210	185-210	273.61	328.33

Technical Drawing

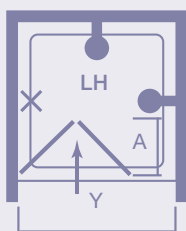

Size	Door Opening Y	Inside Door Swing A
760	471	340
800	504	360
900	588	410
1000	673	455

X: Do not put shower head here
Y: Door Opening

Extension profiles available. See Page 107.



DESIGN IS NOT JUST WHAT
IT LOOKS LIKE. DESIGN IS
HOW IT WORKS.



Steve Jobs



Bifold Door with Side Panel shown as Left Hand (L)

1 DOOR QUADRANTS

Features & Benefits

- Precise, clean lines and slim profile edges contrasted by our signature glass cut-out, creates a crisp minimal enclosure.
- Easy clean enclosure with Mersfield Stayclear and fully concealed fixings minimising cleaning time.
- Designer solid chrome handle gives additional weight and solid feeling to the door.
- Soft close rollers that effortlessly glide to an extra smooth close.



1 Door Quadrant

Size	Code	Adjustment Min-Max	Price £ Exc. VAT	Price £ Inc. VAT
900 x 900	AR61Q90 (L or R)	855-880	762.44	914.92

This product is handed – please choose L for Left and R for Right when ordering. Please Note: Images are for illustrative purposes only. Please refer to the installation guide when fitting the product.

1 Door Offset Quadrant

Size	Code	Adjustment Min-Max	Price £ Exc. VAT	Price £ Inc. VAT
1000 x 800	AR61Q108 (L or R)	955-980/755-780	960.49	1152.58
1200 x 800	AR61Q128 (L or R)	1155-980/755-780	960.49	1152.58
1200 x 900	AR61Q129 (L or R)	1155-1180/855-880	960.49	1152.58

This product is handed – please choose L for Left and R for Right when ordering.



1 Door Quadrant shown as Left Hand (L)

Technical Drawing

Quadrant Door

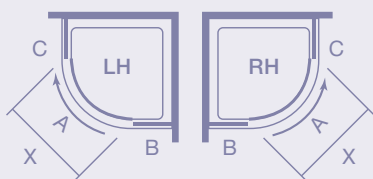

Size	Door Opening	Moving Panel A	Fixed Panel B	Fixed Panel C
900 x 900	475	628	262	497

Offset Quadrant Door

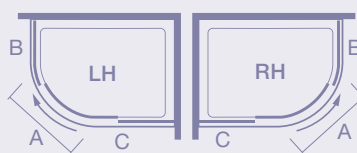

Size	Door Opening	Moving Panel A	Fixed Panel B	Fixed Panel C
1000 x 800	424	570	457	362
1200 x 800	424	570	457	562
1200 x 900	475	628	497	562

A: Door Opening
B: Fixed Panel
C: Straight Panel

X: Door Opening

All sizes to suit a 550mm Radius Tray.
Extension profiles available. See Page 101.

//
SIMPLICITY IS THE
ULTIMATE FORM OF
SOPHISTICATION.

//
Leonardo Da Vinci



1 Door Offset Quadrant shown as Left Hand (L)

THE BATH SCREEN COLLECTION

Shaped and contoured for space and elegance, the MERLYN Bath Screen Collection is the perfect solution for in-bath showering. Innovative design and contemporary aesthetics bring this bathroom favourite to life with modern shapes and features to enjoy for years to come.

SINGLE HINGED BATH SCREEN

Features & Benefits

- › Height 1500mm.
- › Lifetime Guarantee.
- › 10mm toughened safety glass.
- › Mershield Stayclear easy clean coating.
- › Bespoke options available.



Product Information

Size	Code	Moving Panel	Price £ Exc. VAT	Price £ Inc. VAT
1500 x 850	GMBS1	850	737.02	884.42

Please Note: All wall hinges must be secured to a reinforced stud or solid block wall

Please ensure product is fitted with moving panel seals in line with bath inside edge.

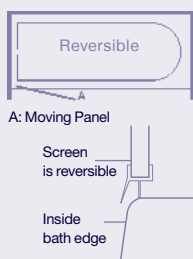

DOUBLE PANEL BATH SCREEN

Features & Benefits

- › Height 1500mm.
- › Lifetime Guarantee.
- › 10mm toughened safety glass.
- › Mershield Stayclear easy clean coating.
- › Bespoke options available.



Product Information

Size	Code	Moving Panel	Fixed Panel	Price £ Exc. VAT	Price £ Inc. VAT
1500 x 1050	GMBS2	750	300	809.13	970.96

Please ensure product is fitted with moving panel seals in line with bath inside edge.

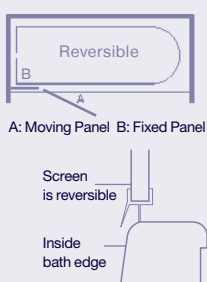

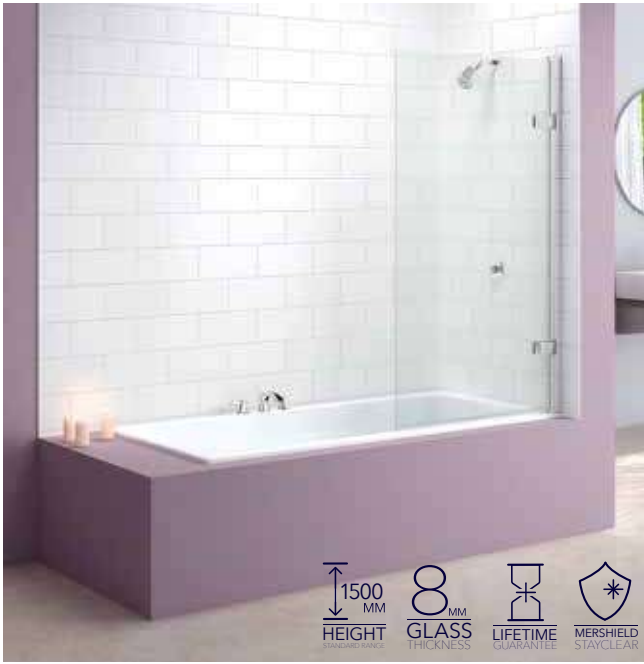







HINGED BATH SCREEN

Product Information

Size	Code	Panels	Price £ Exc. VAT	Price £ Inc. VAT
850 x 1500	MB6	1	512.44	614.92

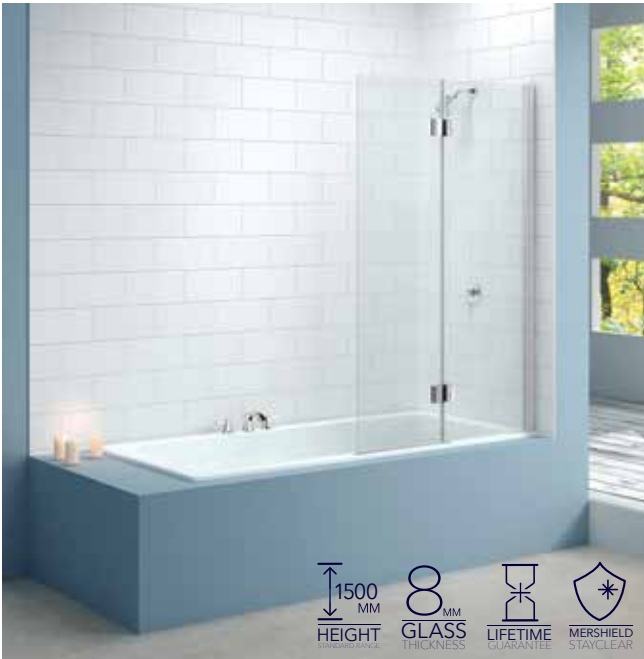
Door Swing: 90° outward swing only
 B: Radius of Screen Swing = 810mm
 ☐ Recommended shower head position
 Please ensure product is fitted with moving panel seals in line with bath inside edge.







2 PANEL HINGED BATH SCREEN

Product Information

Size	Code	Panels	Price £ Exc. VAT	Price £ Inc. VAT
900 x 1500	MB7 (L)	2	624.59	749.51
900 x 1500	MB7 (R)	2	624.59	749.51

Door Swing: 180° inwards only
 A: Fixed Panel = 497mm
 B: Radius of Screen Swing = 383mm
 ☐ Recommended shower head position
 Please ensure product is fitted with moving panel seals in line with bath inside edge.









2 PANEL HINGED BATH SCREEN

Product Information

Size	Code	Panels	Price £ Exc. VAT	Price £ Inc. VAT
850 x 1500	MB7AL (L/H)	2	600.59	720.70
850 x 1500	MB7AR (R/H)	2	600.59	720.70

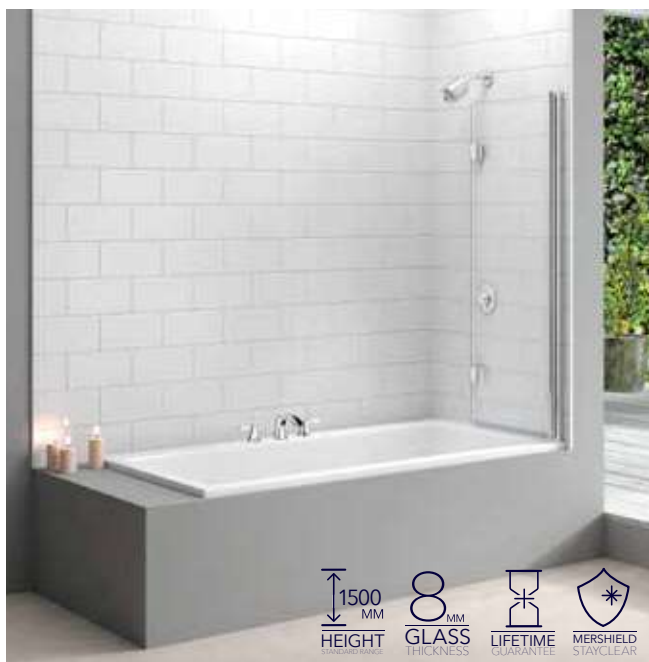
Door Swing: 180° inwards only
 A: Fixed Panel = 505mm
 B: Radius of Screen Swing = 290mm
 ☐ Recommended shower head position



2 PANEL FOLDING BATH SCREEN

Product Information

Size	Code	Panels	Price £ Exc. VAT	Price £ Inc. VAT
1100 x 1500	MB8	2	621.21	745.46

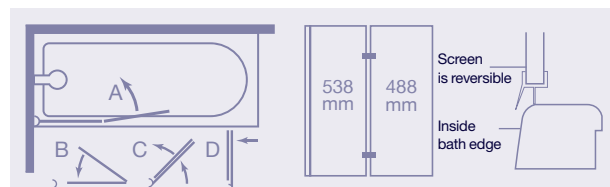

Radius of Screen Swing = 90° inwards and outwards

□ ○ Recommended shower head position

Please ensure product is fitted with moving panel seals in line with bath inside edge.

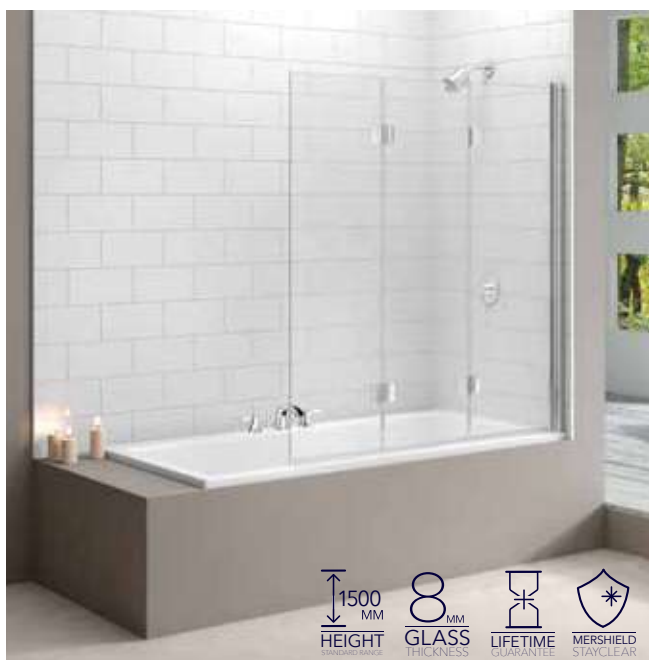

3 PANEL FOLDING BATH SCREEN

Product Information

Size	Code	Panels	Price £ Exc. VAT	Price £ Inc. VAT
1400 x 1500	MB9	3	776.86	932.24

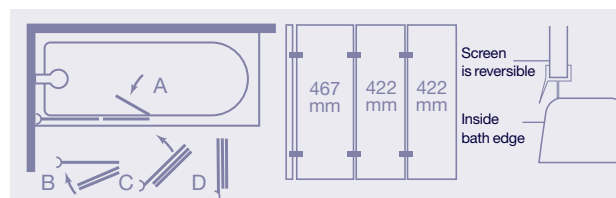

Radius of Screen Swing = 90° inwards and outwards

□ ○ Recommended shower head position

Please ensure product is fitted with moving panel seals in line with bath inside edge.

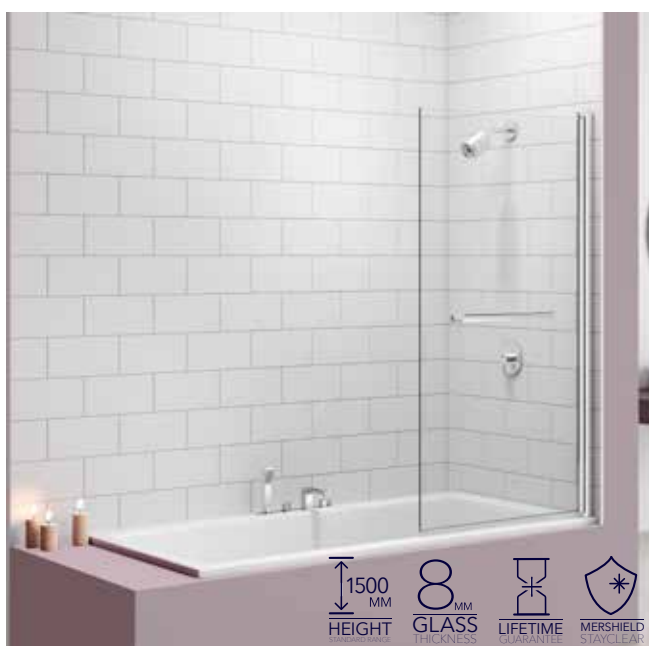

SINGLE SQUARE BATH SCREEN

Product Information

Size	Code	Panels	Price £ Exc. VAT	Price £ Inc. VAT
800 x 1500	MB10	1	504.49	605.38

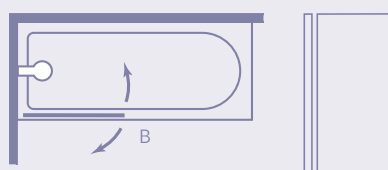

Door Swing: 90° inwards and outwards

B: Radius of Screen Swing = 740 mm

□ ○ Recommended shower head position



1500 MM HEIGHT
 8 MM GLASS THICKNESS
 LIFETIME GUARANTEE
 MERSHIELD STAYCLEAR

SINGLE CURVED PANEL BATH SCREEN

Product Information

Size	Code	Panels	Price £ Exc. VAT	Price £ Inc. VAT
800 x 1500	MB11	1	441.27	529.52

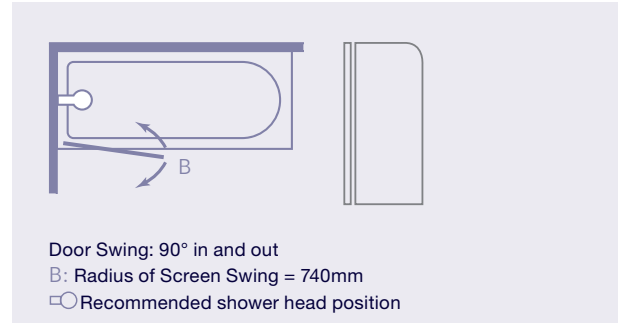

1500 MM HEIGHT
 8 MM GLASS THICKNESS
 LIFETIME GUARANTEE
 MERSHIELD STAYCLEAR

FIXED SQUARE PANEL BATH SCREEN

Product Information

Size	Order Code	Panels	Price £ Exc. VAT	Price £ Inc. VAT
800 x 1500	MB14	1	251.61	301.93

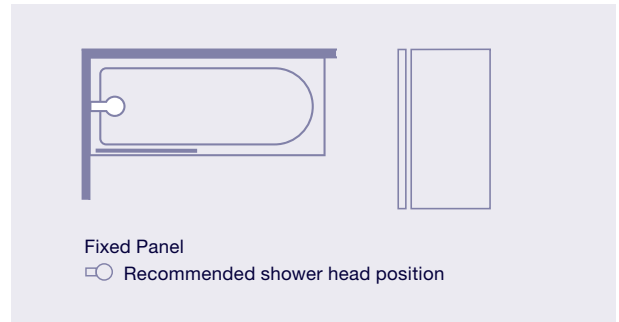



2 PANEL CURVED BATH SCREEN

Product Information

Size	Code	Panels	Price £ Exc. VAT	Price £ Inc. VAT
1150 x 1500	MB3	2	544.79	653.74



Door Swing: 90° in and out

A: Fixed Panel B: Radius of Screen Swing = 733mm

□ ○ Recommended shower head position

Please ensure product is fitted with moving panel seals in line with bath inside edge. This product comes with two glass shelves.

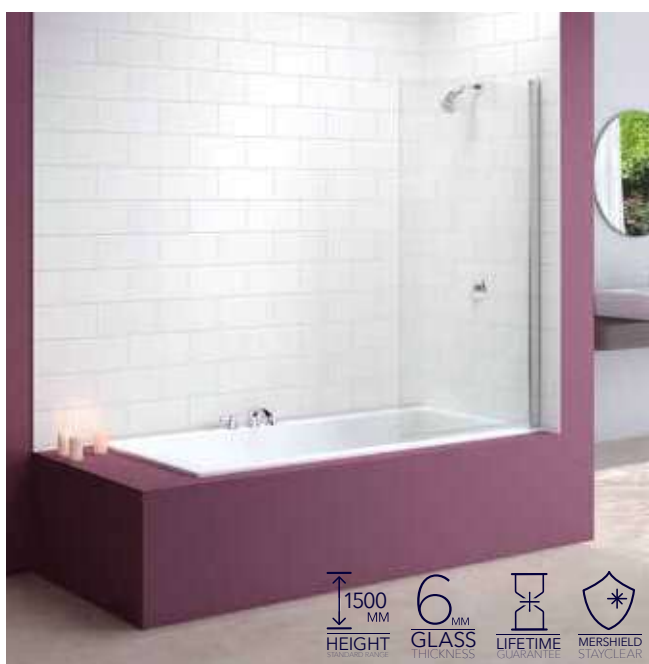

SINGLE SQUARE BATH SCREEN

Product Information

Size	Code	Panels	Price £ Exc. VAT	Price £ Inc. VAT
800 x 1500	MB2	1	230.54	276.65

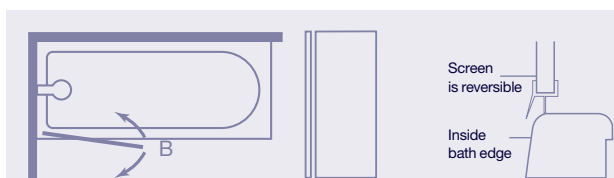

Door Swing: 90° in and out

B: Radius of Screen Swing = 733mm

□ ○ Recommended shower head position

Please ensure product is fitted with moving panel seals in line with bath inside edge.

MERLYN

trays

Beautifully sculpted shower trays, angled and contoured to match all enclosures and spaces, achieving the perfect combination of luxury, elegance and durability.



Truestone Black Shower Tray

LUXURIOUS TEXTURED SLATE TRAYS

Beautifully handcrafted and ultra-low slate trays, elegant in appearance and luxurious to touch. With 5 finishes to choose from - Black, Sandstone, Graphite, White, and Fossil Grey.

These trays will bring an element of natural beauty and a truly designer finish to your bathroom.



Features & Benefits

- › Ultra Slim: only 30mm in height.
- › Handcrafted from high grade stone resin.
- › 5 Colour Options - Black Sandstone, Graphite, White and Fossil Grey
- › Integrated Discreet Waste.
- › Luxurious Textured Finish.
- › Can be fitted on or level with floor.
- › Comes with 90mm Fast Flow Waste.
- › Our self cleaning vortex design: Offers a maintenance free solution as it doesn't require any cleaning
- › Please Note: Images are for illustrative purposes only. The colours and finishes shown in the catalogue are as accurate as possible within the limits of the printing process.

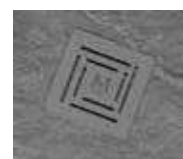

MERLYN Branded Waste Cover

Please ensure that the shower head is not positioned directly over the waste as this may restrict flow rate.

CHOOSE YOUR COLOUR



White
Code W



Fossil Grey
Code F



Graphite
Code G



Black
Code B

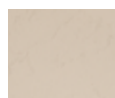

Sandstone
Code S

All tray codes need the corresponding colour code at the end. (See below) e.g. T108RTW

Rectangular Tray (comes with MERLYN 90mm fast flow waste)

Size	Code	Price £ Exc. VAT	Price £ Inc. VAT
1000 x 800	T108RT	574.33	689.20
1200 x 800	T128RT	680.41	816.50
1200 x 900	T129RT	764.18	917.02
1400 x 800	T148RT	756.18	907.42
1400 x 900	T149RT	831.94	998.32
1500 x 800	T158RT	800.11	960.14
1500 x 900	T159RT	1018.34	1222.01
1600 x 800	T168RT	854.67	1025.61
1600 x 900	T169RT	1103.18	1323.82
1700 x 800	T178RT	938.03	1125.63
1700 x 900	T179RT	1139.55	1367.46

All tray codes need the corresponding colour code at the end. (See below) e.g. T108RTW

Quadrant Tray (comes with MERLYN 90mm fast flow waste)

Size	Code	Price £ Exc. VAT	Price £ Inc. VAT
900 x 900	T90Q	540.98	649.18

All tray codes need the corresponding colour code at the end. (See below) e.g. T90QW

Offset Quadrant Tray (comes with MERLYN 90mm fast flow waste)

Size	Code	Price £ Exc. VAT	Price £ Inc. VAT
1000 x 800	T108H (L or R)	709.51	851.41
1200 x 900	T129H (L or R)	831.94	998.32

All tray codes need the corresponding colour code at the end. (See below) e.g. T108HW

This product is handed – please choose L for Left and R for Right when ordering.



Square Tray (comes with MERLYN 90mm fast flow waste)

Size	Code	Price £ Exc. VAT	Price £ Inc. VAT
900 x 900	T90RT	604.64	725.56

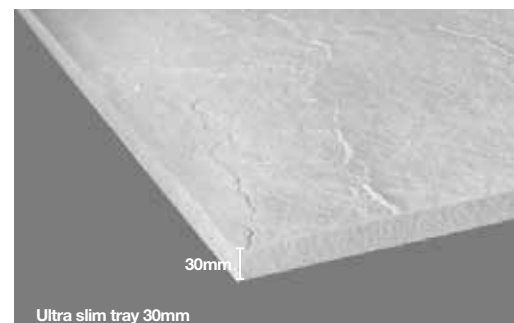

MERLYN SLIP RESISTANT TRAYS



SLIP RESISTANT TRAYS

We have carried out all the testing to give you and your family the peace of mind of showering in a safe environment with the splendour of this natural stone effect.



25 YEARS
GUARANTEE



EASY CLEAN

All you need is a soft cloth and warm soapy water.



QUALITY LOOK AND FEEL

The luxury satin look and feel is designed to give confidence while not feeling harsh underfoot.

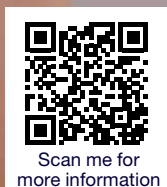

Scan me for
more information



Exceeds Class C for DIN 51097 - Barefoot ramp test.
This ranks MERLYN in a premium class.

LEVEL25^{SR}

The Level25-SR and standard Level25 trays are sleek and ultra slim creating a modern and contemporary feel. At only 25mm high they can be fitted flush to the floor encompassing all the benefits of a wetroom floor and accessibility but without the costly wetroom installation.

Features & Benefits

- › Ultra slim 25mm low level tray.
- › Sleek minimalist design.
- › Discreet integrated waste cover.
- › Can be fitted on or level with floor.
- › The Level25 tray is capped with an easy to clean surface that provides a chemical resistant, anti-bacterial solution due to it's ultra-smooth, non-porous surface.
- › Comes with 90mm fast flow waste.
- › Shower tray 25 year guarantee.
- › Available in square, rectangular and quadrant trays.

Waste Cover



Please ensure that the shower head is not positioned directly over the waste as this may restrict flow rate.

SLIP RESISTANT TRAYS

Rectangular Tray (comes with MERLYN 90mm fast flow waste)

Size	Code	Price £ Exc. VAT	Price £ Inc. VAT
1000 x 800	L108RTAS	447.22	536.66
1000 x 900	L109RTAS	488.06	585.67
1100 x 800	L118RTAS	488.06	585.67
1100 x 900	L119RTAS	488.06	585.67
1200 x 800	L128RTAS	488.06	585.67
1200 x 900	L129RTAS	508.49	610.18
1300 x 800	L138RTAS	726.92	872.30
1300 x 900	L139RTAS	726.92	872.30
1400 x 760	L1476RTAS	726.92	872.30
1400 x 800	L148RTAS	726.92	872.30
1400 x 900	L149RTAS	726.92	872.30
1500 x 800	L158RTAS	782.12	938.54
1500 x 900	L159RTAS	782.12	938.54
1600 x 800	L168RTAS	814.81	977.77
1600 x 900	L169RTAS	814.81	977.77
1700 x 800	L178RTAS	927.10	1112.52
1700 x 900	L179RTAS	933.24	1119.89

Offset Quadrant Tray (comes with MERLYN 90mm fast flow waste)

Size	Code	Price £ Exc. VAT	Price £ Inc. VAT
1200 x 900	L129QLAS	717.64	861.17
1200 x 900	L129QRAS	717.64	861.17

This product is handed – please choose L for Left and R for Right when ordering.

Quadrant Tray (comes with MERLYN 90mm fast flow waste)

Size	Code	Price £ Exc. VAT	Price £ Inc. VAT
900 x 900	L90QAS	523.16	627.79

Square Tray (comes with MERLYN 90mm fast flow waste)

Size	Code	Price £ Exc. VAT	Price £ Inc. VAT
900 x 900	L90SQAS	447.22	536.66



STANDARD TRAYS

Square Tray (comes with MERLYN 90mm fast flow waste)

Size	Code	Price £ Exc. VAT	Price £ Inc. VAT
900 x 900	L90SQ	319.44	383.33



Quadrant Tray (comes with MERLYN 90mm fast flow waste)

Size	Code	Price £ Exc. VAT	Price £ Inc. VAT
900 x 900	L90Q	373.69	448.42

Offset Quadrant Tray

(comes with MERLYN 90mm fast flow waste)

Size	Code	Price £ Exc. VAT	Price £ Inc. VAT
1200 x 900	L129QL	512.60	615.13
1200 x 900	L129QR	512.60	615.13

This product is handed – please choose L for Left and R for Right when ordering.

Rectangular Tray (comes with MERLYN 90mm fast flow waste)

Size	Code	Price £ Exc. VAT	Price £ Inc. VAT
1000 x 800	L108RT	319.44	383.33
1000 x 900	L109RT	348.61	418.33
1100 x 800	L118RT	348.61	418.33
1100 x 900	L119RT	348.61	418.33
1200 x 760	L1276RT	348.61	418.33
1200 x 800	L128RT	348.61	418.33
1200 x 900	L129RT	363.20	435.84
1300 x 800	L138RT	519.24	623.09
1300 x 900	L139RT	519.24	623.09
1400 x 760	L1476RT	519.24	623.09
1400 x 800	L148RT	519.24	623.09
1400 x 900	L149RT	519.24	623.09
1500 x 800	L158RT	558.66	670.39
1500 x 900	L159RT	558.66	670.39
1600 x 800	L168RT	581.99	698.39
1600 x 900	L169RT	581.99	698.39
1700 x 760	L1776RT	581.99	698.39
1700 x 800	L178RT	662.21	794.65
1700 x 900	L179RT	666.60	799.92



PENTANGLE TRAY



Pentangle Tray

The stunning new MERLYN Pentangle Tray is made from a natural stone resin with a luxurious matte white textured finish.

Size	Code	Price £ Exc. VAT	Price £ Inc. VAT
900 x 900	T90PW	559.08	670.89
1200 x 900	T129PWR	623.80	748.56
1200 x 900	T129PWL	623.80	748.56
1400 x 900	T149PWR	660.59	792.70
1400 x 900	T149PWL	660.59	792.70

This product is handed – please choose L for Left and R for Right when ordering.

Features & Benefits

- > 40mm in height.
- > Handcrafted from high grade stone resin.
- > Integrated discreet waste.
- > Luxurious matte textured finish.
- > Comes with 90mm fast flow waste.

TOUCHSTONE-SR

Designed in a beautiful matt white finish without the harsh surface texture, sometimes, experienced in a slip resistant finish. Best in class - Exceeding the requirement in two independently tested industry standards.

Features & Benefits

- > 10 Year Guarantee
- > Single skinned with moulded solid under section
- > 50mm high to achieve minimalist design
- > Antislip is manufactured into the coating and won't wear
- > 135mm high including tray panel kit
- > Compatible 90mm fast flow waste also available

SLIP RESISTANT TRAYS

Rectangular Tray

Size	Code	Tray Panel Kit	Price £ Exc. VAT	Price £ Inc. VAT
900 x 800	S980RTASTO	Kit 4	209.58	251.50
1000 x 800	S108RTASTO	Kit 4	216.44	259.73
1000 x 900	S109RTASTO	Kit 4	224.74	269.69
1100 x 800	S118RTASTO	Kit 4	224.74	269.69
1200 x 700	S127RTASTO	Kit 4	235.45	282.54
1200 x 760	S1276RTASTO	Kit 4	224.74	269.69
1200 x 800	S128RTASTO	Kit 4	249.58	299.49
1200 x 900	S129RTASTO	Kit 4	267.87	321.45
1400 x 700	S147RTASTO	Kit 3	358.06	429.68
1400 x 800	S148RTASTO	Kit 3	358.06	429.68
1400 x 900	S149RTASTO	Kit 3	377.41	452.89
1500 x 760	S1576RTASTO	Kit 3	420.11	504.14
1500 x 800	S158RTASTO	Kit 3	420.11	504.14
1500 x 900	S159RTASTO	Kit 3	442.21	530.65
1600 x 700	S167RTASTO	Kit 3	468.78	562.53
1600 x 800	S168RTASTO	Kit 3	468.78	562.53
1600 x 900	S169RTASTO	Kit 3	492.21	590.65
1685 x 700	S177RTASTO	Kit 3	507.83	609.40
1700 x 800	S178RTASTO	Kit 3	569.56	683.47
1700 x 900	S179RTASTO	Kit 3	613.50	736.19

Offset Quadrant Tray

Size	Code	Tray Panel Kit	Price £ Exc. VAT	Price £ Inc. VAT
1000 x 800 LH	S108QLASTO	Kit 1	237.08	284.50
1000 x 800 RH	S108QRASTO	Kit 1	237.08	284.50
1200 x 800 LH	S128QLASTO	Kit 1	249.58	299.49
1200 x 800 RH	S128QRASTO	Kit 1	249.58	299.49
1200 x 900 LH	S129QLASTO	Kit 1	294.50	353.40
1200 x 900 RH	S129QRASTO	Kit 1	294.50	353.40

This product is handed – please choose L for Left and R for Right when ordering.

Quadrant Tray

Size	Code	Tray Panel Kit	Price £ Exc. VAT	Price £ Inc. VAT
800 x 800	S80QASTO	Kit 2	156.23	187.48
900 x 900	S90QASTO	Kit 2	174.69	209.63

Square Tray

Size	Code	Tray Panel Kit	Price £ Exc. VAT	Price £ Inc. VAT
800 x 800	S80SQASTO	Kit 4	142.81	171.38
900 x 900	S90SQASTO	Kit 4	164.94	197.93

Tray Panel Kits (including Legs)*** No Waste

Tray Panel Kit	Code	Price £ Exc. VAT	Price £ Inc. VAT
Kit 1	DRK1	111.89	134.27
Kit 2	DRK2	111.89	134.27
Kit 3	DRK3	111.89	134.27
Kit 4	DRK4	111.89	134.27

Tray Panel Kit



Graduated adjustable leg and easy-fit tray panel kit.



Graduated adjustable leg system.

Waste Complete

	Price £ Exc. VAT	Price £ Inc. VAT
DWAS	32.52	39.02



90mm fast flow waste, includes hair trap and chrome cover.

Please Note: Price and order codes on the Touchstone-SR **do not** include waste, waste must be ordered separately. **Code: DWAS**





*Image is for illustrative purposes only.

Touchstone-SR Shower Tray

MSTONE

A highly engineered tray providing rigidity and strength and combined with a relatively low weight. MStone trays are ideal for 'low level' installation. Alternatively, you can raise your tray and in such cases you will need the MStone shower tray panel kit.

Features & Benefits

- › Double skinned for added rigidity.
- › 50mm high to achieve minimalist design.
- › 130mm high including tray panel set.
- › The MStone tray is capped with an easy to clean surface that provides a chemical resistant, anti-bacterial solution due to it's ultra-smooth, non-porous surface.
- › Comes with 90mm fast flow waste.
- › More than 30 sizes available.
- › Available as low level or with tray panel kits for easy installation.
- › Shower tray lifetime guarantee.

MSTONE

MERLYN SHOWER TRAYS



MStone Rectangular Tray

STANDARD TRAYS

Rectangular Tray (comes with MERLYN 90mm fast flow waste)

Size	Code	Tray Panel Kit (Order Separately)	Price £ Exc. VAT	Price £ Inc. VAT
900 x 760	D976RT	Kit 4	220.55	264.66
1000 x 800	D108RT	Kit 4	252.69	303.23
1100 x 760	D1176RT	Kit 4	279.24	335.09
1100 x 800	D118RT	Kit 4	268.57	322.28
1200 x 700	D127RT	Kit 4	265.38	318.46
1200 x 760	D1276RT	Kit 4	265.38	318.46
1200 x 800	D128RT	Kit 4	271.74	326.08
1200 x 900	D129RT	Kit 4	287.61	345.13
1400 x 800	D148RT	Kit 3	396.67	476.00
1400 x 900	D149RT	Kit 3	412.84	495.41
1500 x 700	D157RT	Kit 3	451.65	541.98
1500 x 800	D158RT	Kit 3	451.65	541.98
1500 x 900	D159RT	Kit 3	451.65	541.98
1600 x 800	D168RT	Kit 3	529.72	635.67
1600 x 900	D169RT	Kit 3	530.89	637.07
1685 x 700	D177RT	Kit 3	535.76	642.91
1680 x 760	D1776RT	Kit 3	535.76	642.91
1700 x 800*	D178RT	Kit 3	629.21	755.06

Tray Panel Kit (including Legs)

DRK3	Kit 3	111.89	134.27
DRK4	Kit 4	111.89	134.27



*Waste is centered for 1700x800 tray - D178RT

Square Tray (comes with MERLYN 90mm fast flow waste)

Size	Code	Tray Panel Kit (Order Separately)	Price £ Exc. VAT	Price £ Inc. VAT
760	D76SQ	Kit 4	144.79	173.75
800	D80SQ	Kit 4	160.67	192.81
900	D90SQ	Kit 4	224.14	268.97

Tray Panel Kit (Including Legs)

1200 x 900	DRK4	Kit 4	111.89	134.27
------------	-------------	-------	--------	--------



Offset Quadrant Tray (comes with MERLYN 90mm fast flow waste)

Size	Code	Tray Panel Kit (Order Separately)	Price £ Exc. VAT	Price £ Inc. VAT
900 x 760	D976QL	Kit 1	299.87	359.84
900 x 760	D976QR	Kit 1	299.87	359.84
1000 x 800	D108QL	Kit 1	287.61	345.13
1000 x 800	D108QR	Kit 1	287.61	345.13
1200 x 800	D128QL	Kit 1	301.87	362.24
1200 x 800	D128QR	Kit 1	301.87	362.24
1200 x 900	D129QL	Kit 1	317.73	381.27
1200 x 900	D129QR	Kit 1	317.73	381.27

This product is handed – please choose L for Left and R for Right when ordering.

Tray Panel Kit (including Legs)

1200 x 900	DRK1	Kit 1	111.89	134.27
------------	-------------	-------	--------	--------



Quadrant Tray (comes with MERLYN 90mm fast flow waste)

Size	Code	Tray Panel Kit (Order Separately)	Price £ Exc. VAT	Price £ Inc. VAT
800	D80Q	Kit 2	205.10	246.12
900	D90Q	Kit 2	224.14	268.97
1000	D100Q	Kit 5	291.36	349.63

Tray Panel Kit (including Legs)

900	DRK2	Kit 2	111.89	134.27
1000	DRK5	Kit 5	111.89	134.27

MERLYN Dedicated Offset Quadrant Tray (1400x800)

Size	Order Code	Price £ Exc. VAT	Price £ Inc. VAT
1400 x 800	S148Q L or R	343.97	412.77

Please Note: The 1400mmx800mm tray is not an MStone Tray, it is a dedicated single skinned tray.

Image shown as Left Handed (L) Please choose L for Left or R for Right when ordering.



Waste Complete

	Price £ Exc. VAT	Price £ Inc. VAT
DWAS	32.52	39.02

PRODUCT INFORMATION

- All products are manufactured in accordance with EN 14428 and utilise toughened safety glass to EN 12150. Electrical products comply with all relevant European standards including RoHS, WEEE and IP ratings.
- All doors feature adjustable wall profiles to compensate for out-of-true walls and have micro adjustment features for fine tuning to obtain a perfect fit and operating action.
- All wall hinge doors need to be fixed to a solid wall or adequately secure fixing.
- All standard products are supplied complete with full installation instructions and the necessary fixings.
- Bespoke sizes cannot be cancelled once order has been processed.
- Product descriptions do not imply the use of precious or valuable materials.
- Bath screens are not designed to fit on baths with stepped fronts roll top rims or integral soap dishes.
- Standard Products - Opened cartons can not be returned. Returns carry a £40 single box charge or £60 per unit where the sale is less than 30 days old. Returns over 30 days old will not be accepted. MERLYN do not accept returns on any bespoke products.
- ARYSTO TEN by MERLYN is frameless in design. Spray/mist may escape therefore we would recommend use of these enclosures with tiled floors.
- Water retention is maintained in all products under normal showering conditions. Water jetted, with pressure, directly at joints, seals or openings can naturally force an exit.
- All enclosures, wetrooms and panels are Power Shower approved – will retain water under normal showering conditions.
- Only shower enclosures, panels and bath screens are covered by the lifetime guarantee. Please contact the MERLYN sales team for more details.
- For full details on all product ranges please contact MERLYN.
- Glass shattering and parts subject to wear are not covered by the lifetime guarantee. Electrical products have a 5 year guarantee and are not covered by the lifetime guarantee.
- Chrome and Nickel components may differ due to the use of different materials. Please check with your MERLYN Arysto dealer for accurate matching of material samples.
- Images are for illustrated purposes only. The colours and finishes shown in the catalogue are as accurate as possible within the limits of the printing process. The positioning of all showering heads in the brochure is for illustrative purposes only.
- Do not direct water directly at the eyelet handle as water will pass through. It is the responsibility of the designer / installer to ensure that the shower head is positioned so this is not an issue.

N.B. We strongly recommend that you use a MERLYN recognised Surveyor and Fitter. CAD or scaled drawings are required especially for sloping panels and panels with dwarf walls. All drawings need to be signed off.

LIFETIME GUARANTEE

At MERLYN research and development is an integral part of the business. All products go through rigorous testing processes so much so that we can confidently stand behind our products and therefore we offer a Lifetime Guarantee covering all manufacturing defects ensuring ultimate peace of mind.

Glass shattering and parts subject to wear are not covered by the lifetime guarantee. Electrical products have a 5 year guarantee and are not covered by the lifetime guarantee.

Please note that the Mershield is not covered under the guarantee as it is solely dependent on the owner's water supplier and the level of care and maintenance it receives.

MERLYN Customer Service

T: United Kingdom 0808 1011 429 / Ireland 056 779 1555

UKCA, CE AND EN INFORMATION

The UKCA (UK Conformity Assessment) mark on MERLYN enclosures is the new standard marking for products on the market in Great Britain (England, Wales and Scotland). It is a declaration that the product complies with GB designated standards.

The CE markings on Merlyn enclosures is a declaration that the product complies with the essential requirements of the relevant European health, safety and environmental protection legislation.

EU and GB legislation requires manufacturers to display either the UKCA mark for Great Britain and a CE mark for the EU and Northern Ireland on their product or packaging. It is an offence to place a product on the relevant market without a UKCA for Great Britain or CE marking for the EU market.

The UKCA marking came into effect on 1st January 2021. However, to allow businesses time to adjust to the new requirements, CE marking can still be used in GB until 1st January 2022. The manufacturer is legally responsible for ensuring that the product conforms to the requirements of both directives.

The European Commission thus refers to the CE marking as a "Passport" which allows products to be freely circulated within the EU single market. The UKCA marking allows products to move freely within Great Britain.

Often consumers will consider the UKCA and CE markings on a product as an indication of conformance to laid down minimum standards and therefore, a minimum level of safety which other products may lack. Both markings are often seen by consumers as a "Symbol of Safety."

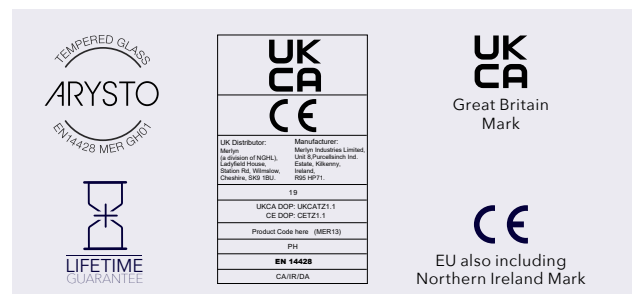

IMPORTANT

For bespoke sizes please provide overall measurements i.e. tile-to-tile or tile-to-outside edge of tray, all surfaces including trays, walls and floors, all angles and cut-outs etc.

MERLYN accept no responsibility for any incorrect measurements and details provided by customers or retailers. Any order placed to correct the mistake is treated as a new order and will be charged as such. MERLYN do not accept any returns on any bespoke products.

Important Shower Tray Information

Although shower door and enclosure sizes are related to tray sizes it is important to note that most shower trays are tiled down to the rim, often over an "up-stand". The finished installation space may be less than the nominal tray size. MERLYN Arysto shower enclosures are made to suit this remaining space.

The illustrated guide (diagrams on right of page) may be helpful in taking measurements to determine the shower door or enclosure size required. Dimensions given in this publication are in millimetres, are approximate and may vary with adjustment. They are subject to change without notice.

N.B. Please note that when a tray is fitted it is essential that the tray is level before any doors or enclosures are fitted.

Tray

Ensure strong and secure joints between shower tray and walls, even in the event of floor settlement.

Please supply floor plans, photos, site condition details and note anything that might obstruct the product. Special sizes cannot be cancelled once the order has been processed.

Adjustment

This is the min and max adjustment of the actual enclosure. Always ensure the outer most part of the enclosure frame is stepped in far enough from the edge of the tray so that the enclosure frame is sitting on a flat surface and can be sealed correctly. Some trays have larger rounded edges and may need a bigger step in. Ensure that the step in leaves adequate space for the product adjustment.

N.B. Take the measurements after the tray is installed and the walls are tiled.

Disposal and Recycling End of product life

When the product reaches the end of its serviceable life it needs to be disposed of safely and brought to or collected by an approved authorised treatment facility.

Batteries

Used batteries need to be disposed of responsibly and not with your normal household waste. Please contact your local authority for information on recycling and safe disposal.



Measurement Guide

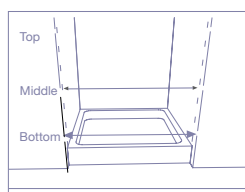

Diagram 1 Recess Location

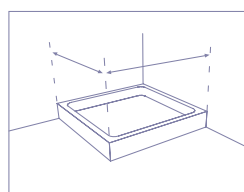

Diagram 2 Corner Location

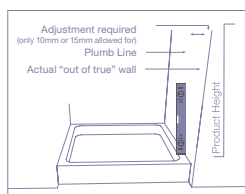

Diagram 3 Out of True Wall

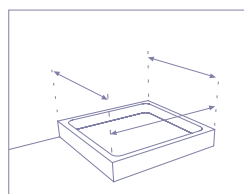

Diagram 4 Wall Location

IMPORTANT SHOWER TRAY INFORMATION

- › It is up to the designer or installer to ensure that the tray and enclosure combination is arranged in such a way that water retention meets the customers needs.
- › The waste has the capacity to carry away 29L/Min. High powered systems may exceed this. Please check with the manufacturer.
- › Please ensure that the shower head is not positioned directly over the waste as this may restrict water flow rate.
- › Please ensure that the colour and size of shower tray are as per your order before installation.
- › You must inspect the product thoroughly before installation. Fitting the product is acceptance of quality.
- › The trays are handmade from natural material. Please allow for height variances due to manufacturing tolerances.
- › For open ended shower screens please consult your installer.

ISO CERTIFICATION

MERLYN has implemented an Integrated Management System comprising of Quality Management, Environmental Management and Occupational Health and Safety Management. An Integrated Management System ensures the seamless integration of several different standards into a common system that meets the requirements of each of these standards. These certifications are proof of MERLYN's credibility but also to instil confidence in our potential clients that MERLYN will keep its promises.



- › Shower trays must be fitted as per the fitting instruction. Deviation from the pre installation checks or fitting installation will void the guarantee.
- › When wet, the surface of the majority of shower trays will show an increase in the potential for slipping. This is particularly the case when soap, shampoo, bath oil etc. are used. It is important that designers, installers and users are aware of this.

CLEANING

- › It is important to clean your MERLYN shower door after every use.
- › Wipe down all the glass and metal parts with a soft cloth.
- › Do not allow lime scale to build up in hard water areas.
- › Ensure that any residual water on the glass is removed after every use.
- › Clean the glass regularly using soapy water.
- › Do not use abrasive products on any surfaces.
- › Install the enclosure in a well ventilated area.
- › When cleaning your ARYSTO X do not direct a high pressure stream at the seals or at a point of overlap between 2 panels as some water may escape.

Information and Maintenance

Always read the instructions on the packaging. Chrome is vulnerable to acid attack and some strong household cleaners including strong disinfectants, denture cleaners, hair dyes, wine making chemicals and photographic chemicals may contain acid. These materials may have a varying effect on the surface from black spots/streaks (which cannot be removed) to pitting the surface. Contact with these materials should be avoided.

CONTACT

The MERLYN Arysto collection is available from specialist retail showrooms only. Our dedicated and highly trained MERLYN Sales Team are waiting to provide all the professional assistance and advice needed to help you choose the right enclosure.

For MERLYN Customer Service including product enquiries please call us on UK: 0808 1011429 / IRL 056 779 1555 or visit our website at www.merlynshowering.com.

Due to our policy of continuous improvement we reserve the right to amend prices, specifications and designs without prior notice.

All material and illustrations included in this catalogue are the copyright of MERLYN Industries Ltd. and cannot be used without prior written permission and credit in any other advertisements, brochures, publication, correspondence, any medium what so ever whether written or electronic including the internet.

All Rights Reserved.

EXTENSION PROFILES

Diagram	Section	Product Name	Code	Price £ Exc. VAT	Price £ Inc. VAT
A	Arysto 6	-	AR6EXT	74.41	89.29
B	Arysto 8	Sliding Door	AR8SEXT	85.00	102.00
C	Arysto 8	Infold Door	AR8NFEXT1	85.00	102.00
D	Arysto 8	Infold Side Panel	AR8NFEXT2	85.00	102.00

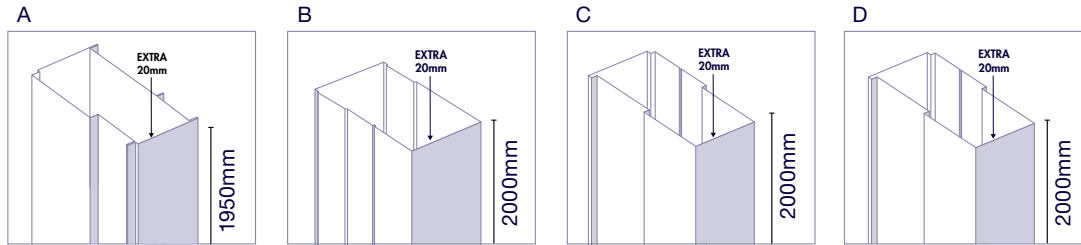

WASTE POSITIONS

TrueStone Trays

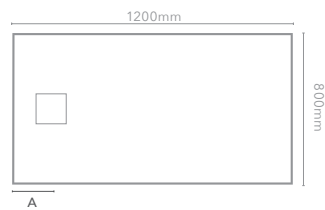

Rectangular Tray

Size	Waste Position (A)	Waste Position (B)
1000 x 800	200	400
1200 x 800	250	400
1200 x 900	250	450
1400 x 800	350	400
1400 x 900	350	450
1500 x 800	400	400
1500 x 900	400	450
1600 x 800	450	400
1600 x 900	450	450
1700x800	500	400
1700 x 900	500	450

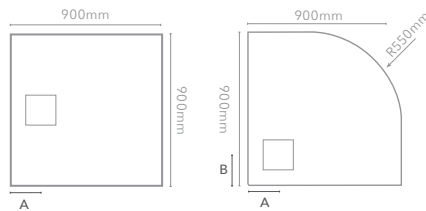

Square Tray

Size	Waste Position (A)	Waste Position (B)
900 x 900	270	450

Quadrant Tray

Size	Waste Position (A)	Waste Position (B)
900 x 900	270	270

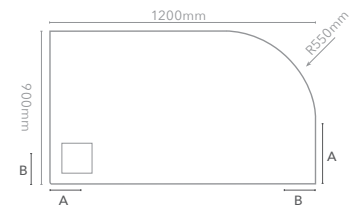

Offset Quadrant Tray

Size	Waste Position (A)	Waste Position (B)
1200x900	270	270

Please Note: For all trays, waste dimensions are to the centre of waste.

Level 25 Trays

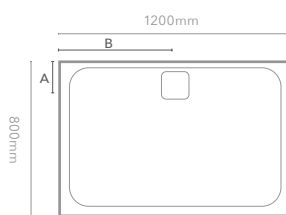

Rectangular Tray

Size	Waste Position (A)	Waste Position (B)
1000 x 800	121.5	500
1000 x 900	121.5	500
1100 x 800	121.5	550
1100 x 900	121.5	550
1200 x 800	121.5	600
1200 x 900	121.5	600
1300 x 800	121.5	650
1300 x 900	121.5	650
1400 x 800	121.5	700
1400 x 900	121.5	700
1500 x 800	121.5	750
1500 x 900	121.5	750
1600 x 800	121.5	800
1600 x 900	121.5	800
1700 x 800	121.5	850
1700 x 900	121.5	850

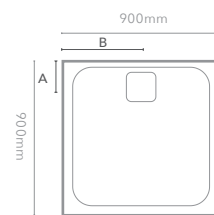

Square Tray

Size	Waste Position (A)	Waste Position (B)
900 x 900	121.5	450

Quadrant Tray

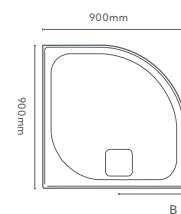

Offset Quadrant Tray

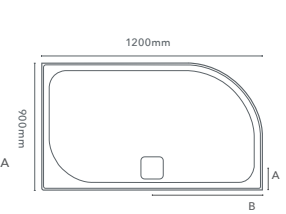

Quadrant Trays

Size	Waste Position (A)	Waste Position (B)
900 x 900	121.5	450
1200 x 900	121.5	600

Quadrant Tray Handing



Left Handed (L) Right Handed (R)

This product is handed. Please choose L for Left or R for Right when ordering.

WASTE POSITIONS

MStone Trays

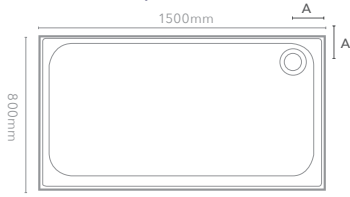

Rectangular Tray

Size	Waste Position (A)	Waste Position (B)
900 x 760	147	
1000 x 800	147	
1100 x 760	147	
1100 x 800	147	
1200 x 700	147	
1200 x 760	147	
1200 x 800	147	
1200 x 900	147	
1400 x 800	147	
1400 x 900	147	
1500 x 700	147	
1500 x 800	147	
1500 x 900	147	
1600 x 800	147	
1600 x 900	147	
1685 x 700	147	
1680 x 760	147	

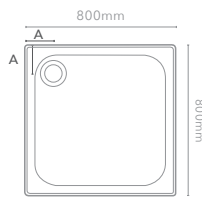

Square Tray

Size	Waste Position (A)	Waste Position (B)
760	147	
800	147	
900	147	

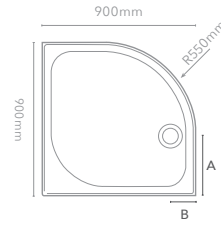

Quadrant Tray

Size	Waste Position (A)	Waste Position (B)
800	250	130
900	350	130
1000	350	130

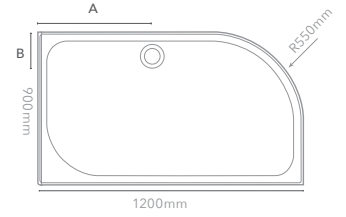

Offset Quadrant Tray

Size	Waste Position (A)	Waste Position (B)
900 x 760 L	250	130
900 x 760 R	250	130
1000 x 800 L	350	130
1000 x 800 R	350	130
1200 x 800 L	450	130
1200 x 800 R	450	130
1200 x 900 L	450	130
1200 x 900 R	450	130
1400 x 800 L	510	300
1400 x 800 R	510	300

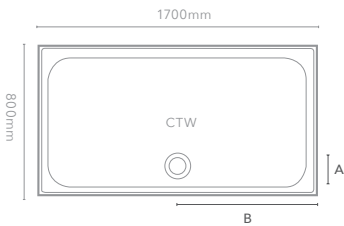

Rectangle Tray

Size	Waste Position (A)	Waste Position (B)
1700 x 800	147	850

Waste is centred for 1700x800 tray - D178RT

Pentangle Tray

Pentangle Tray

Size	Waste Position (A)	Waste Position (B)
900 x 900	200	250
1200 x 900	200	250
1400 x 900	200	250

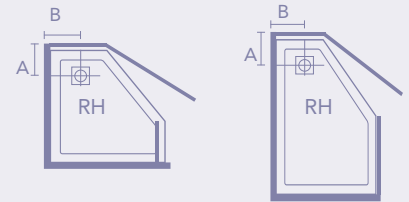

ARYSTO TEN

YOUR SPECIAL GIFT

As a special gift, we include this complimentary MERLYN Glass Wiper and Holder with each complete ARYSTO TEN product purchased worth just under £50.

You can also purchase these for other ranges (price details below).

Order Code

MG201WIPER	50.53	60.64
------------	-------	-------



MERLYN GLASS SHELF

Order Code

DWHSHELF	125.46	150.55
----------	--------	--------



www.merlynshowering.com

MERLYN™

Unit 8, Purcellsinch Industrial Estate, Dublin Road, Kilkenny, Ireland, R95 HP71.

T UK: 0808 1011 429 / IRL: 056 7791 576 or E sales@merlyn.ie

www.merlynshowering.com



MERLYN™
ARYSTO

