



ACCESSIBLE LIVING | ASSISTED CARE SHOWERING | INDEPENDENT LIVING CARE

impey

WWW.IMPEYSHOWERS.COM

Why specify Impey?

Apart from our pride in being a UK manufacturer here are some reasons why Impey are the number one choice for specialist wetroom healthcare solutions.

With over 25 years' experience, we provide a 'fit for purpose' healthcare solution	Over 500,000 successful installations in the UK
Innovations can be found everywhere across the Impey range; original ideas that redefine what's possible, adding value and bringing real installer and customer benefits	Innovations that make life easier
Every member of the sales team is fully qualified to advise on all aspects of our products and installation	Unbeatable service
At every opportunity, we advance our systems and processes to improve the customer journey, every step of the way	Committed to our customers
All Impey products conform to ISO 14001 reinforcing our commitment to the environment	Environmental responsibility
We use only the best materials and rigorous construction methods to ensure the greatest quality and reliability	Failsafe quality and reliability

On-site design surveys and CAD drawings available	Impey provide bespoke survey design requirements to create ideal solutions
---	--

Full technical support and training for all installations	Unrivalled product support
---	-----------------------------------

The home of the UK's leading wetroom floor former	Level-Dec EasyFit™. Revolutionary design and unique to Impey
---	--

We have a dedicated Technical team, offering you instant access to our unmatched specialist knowledge	Comprehensive, risk-free healthcare solutions
---	--

Cost saving installation	Most of our products can be easily fitted by a single installer. Our carefully considered product design ensures minimal installation time
--------------------------	--

Wetroom and level-access showering for the Care market.

Impey was founded on providing specialist wetroom showering solutions for people with mobility difficulties, pioneering many of the product innovations that now lead the market. Our range of products include walk-in wetroom shower floors for vinyl floor coverings, low access shower trays, shower doors, support rails, shower seats and accessories.

We design innovative, high quality products for the health and care sectors. We work closely with contractors, installers, local authorities and healthcare professionals to provide high quality wetroom solutions for all types of bathroom adaptation, improving the lives of thousands of people every year.

All products are created by our highly skilled team of designers. All backed up by industry standard testing and our in-house technical, surveying and installation support teams.



Contents

Why specify Impey?	2
UK Manufacturing	4
Shower Planning Guide	8
Wetroom Floor Formers	10
Shower Trays	18
Drainage	38
Shower Doors, Panels, Screens and Curtains	42
Shower Seats	58
Grab Rails, Hand Rails and Accessories	66
Boston Comfort & Safety Range	72
Mixer and Electric Showers	74
Showers & Waste Pump Kits	80
Toilets and Bathroom Accessories	84
Floor and Door Options	88
Impey Guarantee	94

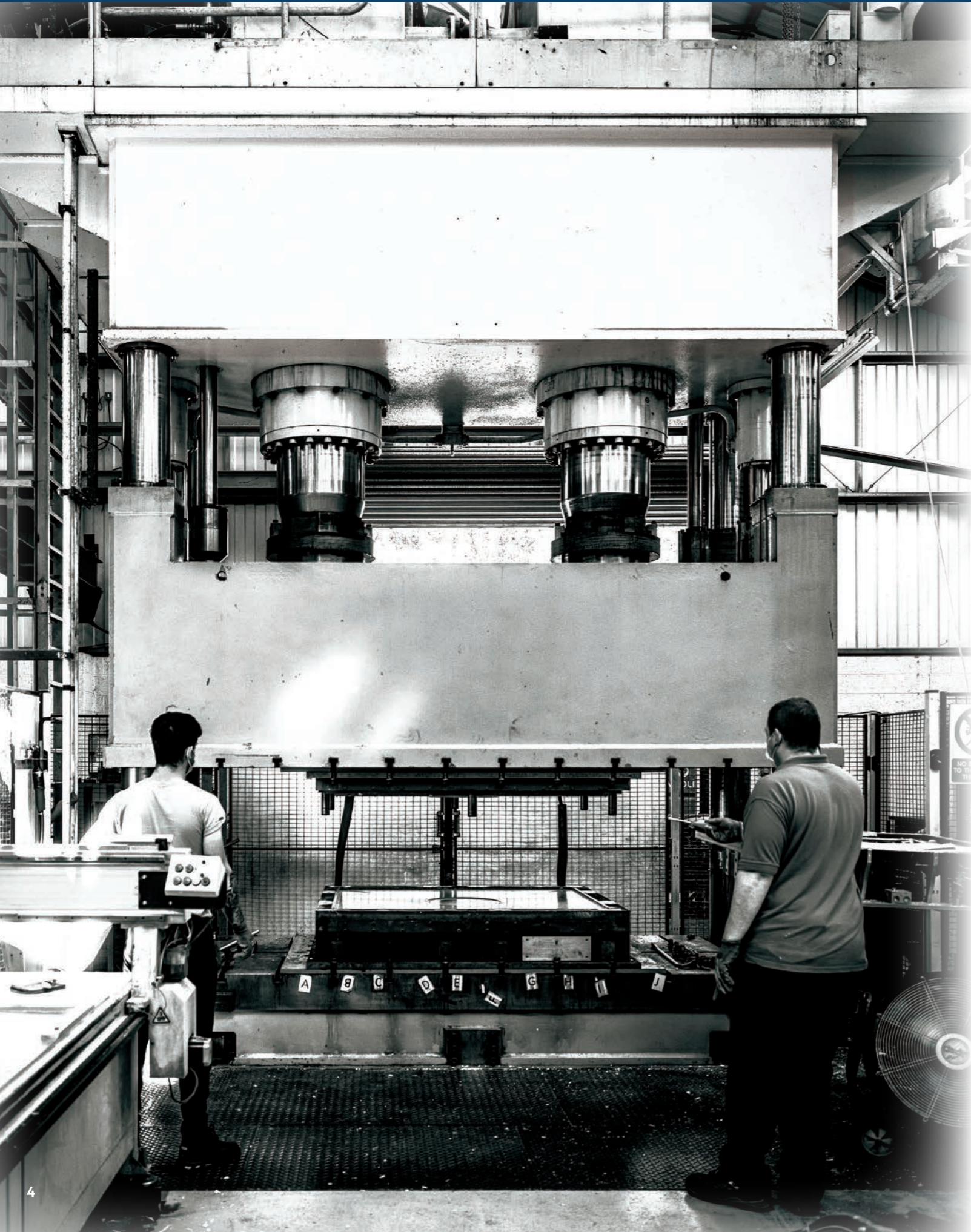

Made in the UK

As a UK-based manufacturer, we are proud to employ a local workforce at our manufacturing site in Bridgnorth, Shropshire, as well as at our head office in Ilton, Somerset.

At our Bridgnorth factory, we have integrated a variety of streamlined, modern manufacturing processes across the Impey product range to ensure all our products are of unparalleled quality and produced as efficiently as possible. Each Impey product is made with the highest levels of care and attention to detail.

We have invested in a wide variety of advanced manufacturing processes to enable us to deliver market-leading solutions, across a wide range of technologies. All supported with our own design, engineering and continuous improvement teams. These drive the use of new materials, in-house tooling, processes and offerings, whilst ensuring compliance through our own CE testing facility.

Having all supporting departments based in Ilton, we can consistently deliver a high level of customer service with confidence. All of our employees are product trained by our Technical team so they are able to provide the best advice and solutions to all of our customers.



Watch our UK Manufacturing video

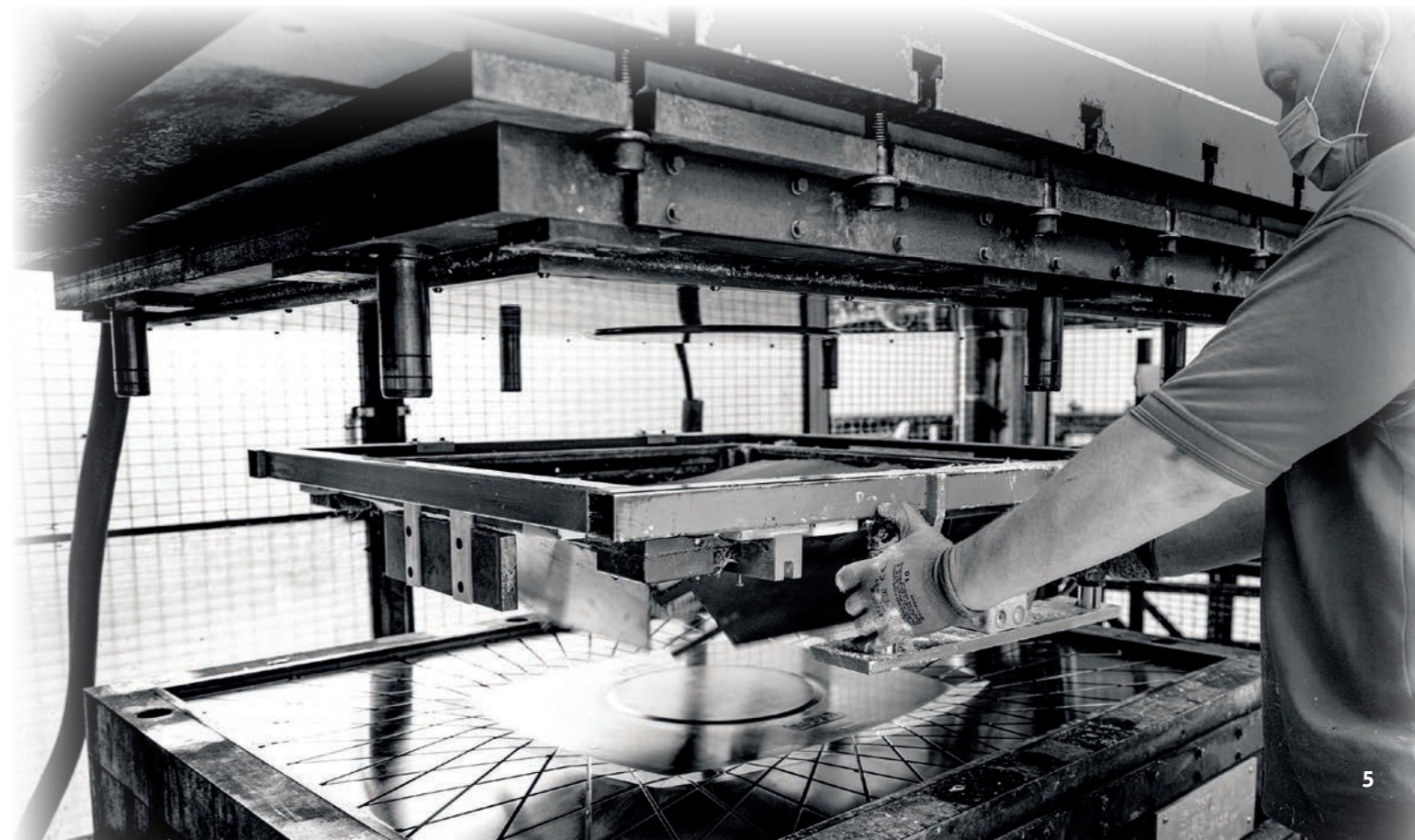

Manufacturing capabilities in Bridgnorth

With over 25 years of complete manufacturing based within the UK, we have been able to adapt and improve our manufacturing techniques and progress our products by doing so. Some of these processes include:

- Manufacturing Level-Dec EasyFit™ is a semi-automated thermoset compression process. The SMC material is manually fed onto a mold which is heated to approximately 145°C. The mold sits in a hydraulic press which is manually operated to close the tool and apply pressures of up to 800 ton on a floor former. Under both compression and heat the material liquefies and fills the tool cavity before re-solidifying and hardening. The floor former is then lifted off by two team members, in unison, and checked. It then undergoes a post process operation which involves the removal of the centre drainage area by a machine process and is finished by hand

- The manufacture of our Half Height Shower Doors involves sawing, bending and drilling of aluminium extrusions which is then assembled into a frame or support. The frame structure is secured to plastic panels using either adhesives or screws and gaskets. Extensive hand operated poka yoke tooling, used to deliver agile response times on products

- The process of manufacturing GRP Shower Trays uses spray gel, resin and glass chop. A mold is taken and a spray coating of white gel coat is applied and left to cure for half an hour. Next several coats of resin and glass chop is applied and rolled out in the mold. It is then left to cure for several hours

- Thermoform processes to provide Shower Tray options, all backed up with CNC (Computer Numerical Control) trimming capacity to ensure dependability.

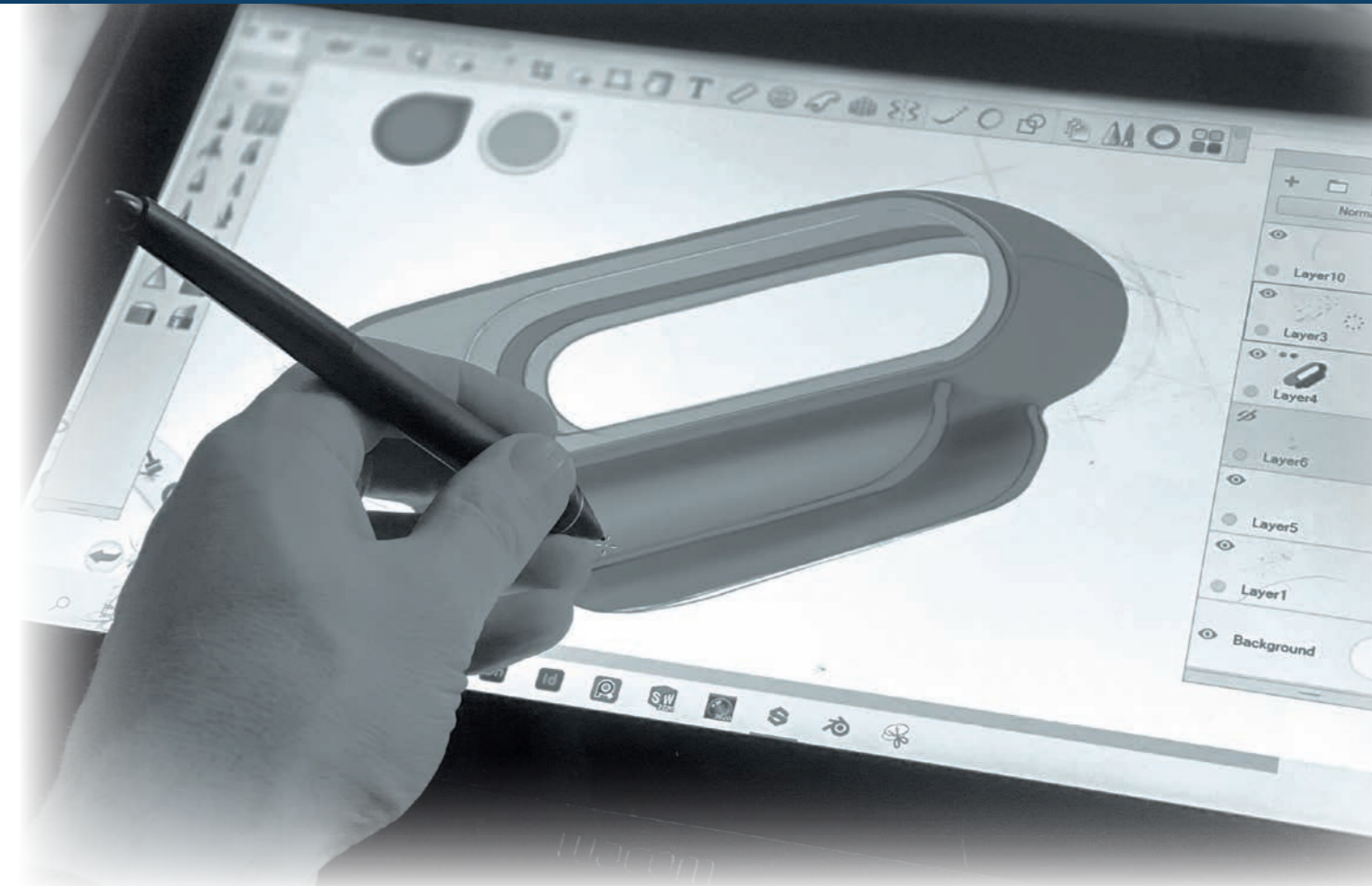
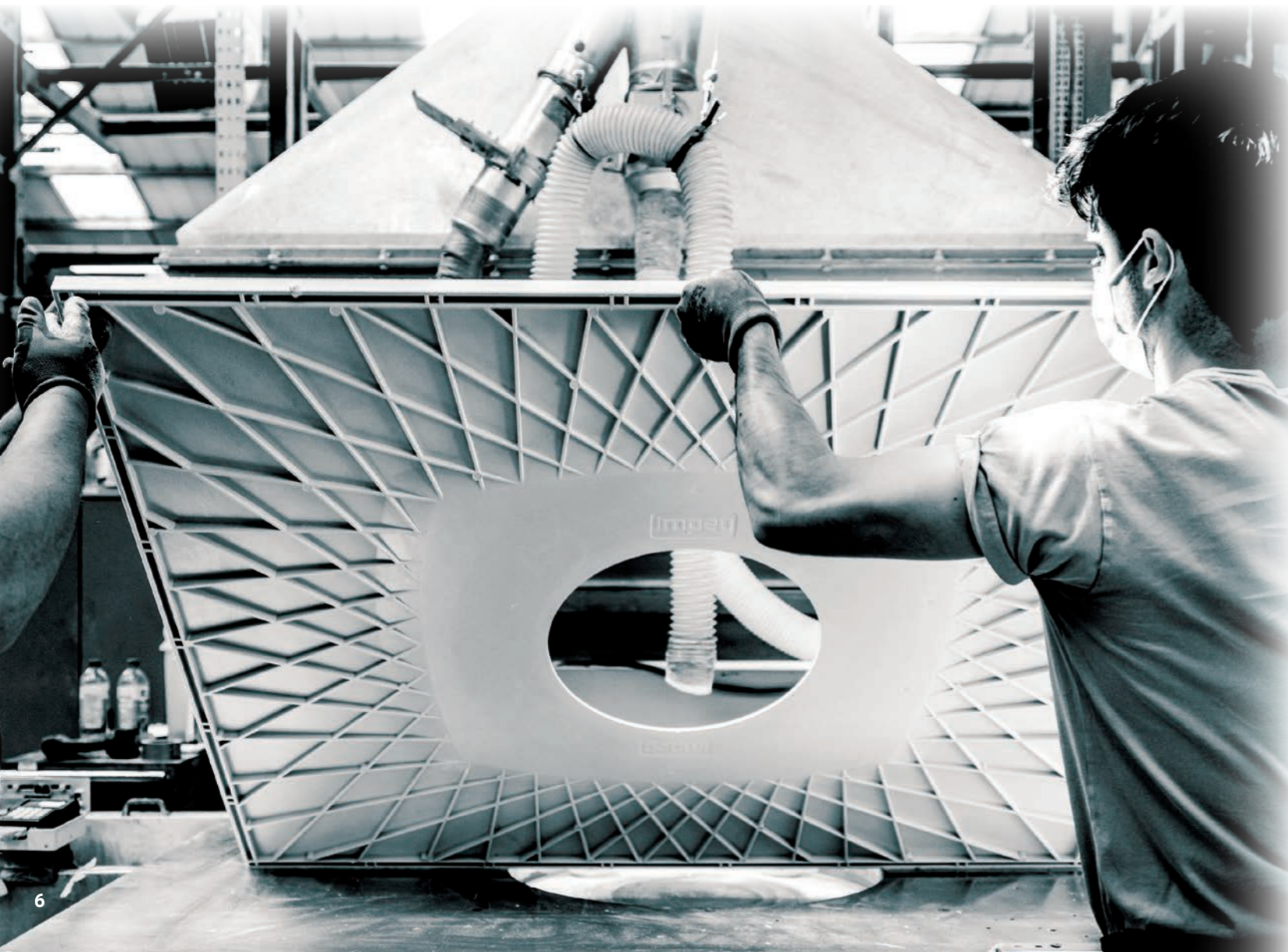

Research & Development in Ilton

At Impey, we pride ourselves on leading the way in innovation for wetrooms and accessible bathrooms. As experts in healthcare showering, our easy-access solutions are high-performance, watertight and can be easily fitted into an existing bathroom, offering complete showering

freedom. Combining enhanced functionality and improved performance with stylish and contemporary design, it is simple to create a tailored showering space that is modern, attractive and caters to exact mobility requirements.



Shower Planning Guide

Step 1: Floor

Wetroom Floor Formers

Creating 100% level-access on wood or concrete floors

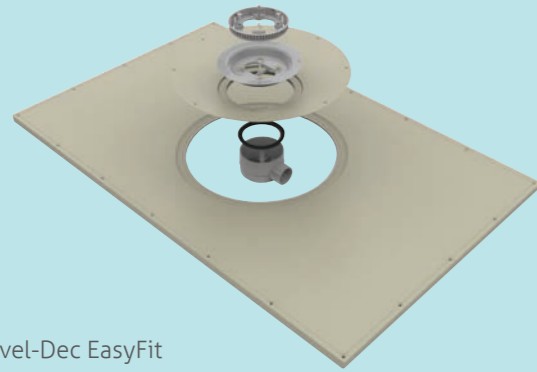

Level-Dec EasyFit
Pages 12 - 15

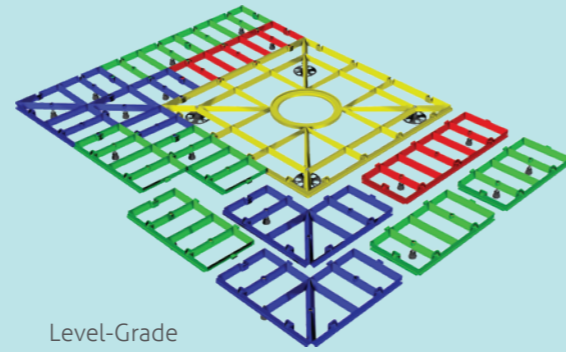

Level-Grade
Pages 16 - 17

Shower Trays

Enabling showering on an unbreachable floor



Radiate
Pages 20 - 23



Mendip
Pages 24 - 27

Low Level Shower Trays

An alternative to wetroom floor formers



Mantis
Pages 30 - 33



Slimline
Pages 34 - 37

Step 2: Drainage

Waste fittings come as standard with all Impey wetroom floor formers and shower trays, but we also offer alternative options including pumped and slimline drainage. Pages 38 - 41

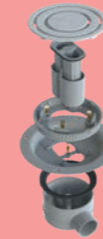

Gravity drain for
floor formers



Slimline drain
for floor formers



Gravity drain for
shower trays



Pumped drain
for shower trays

Step 3: Shower Doors, Panels, Curtains and Screens

Once you have selected the size of wetroom floor former or shower tray you can then choose from a wide range of hinged folding or sliding doors as well as shower panels, curtains and freestanding carer screens.

Half Height Doors
Pages 44 - 49



NEW

Double Bi-Fold
Doors with
Coving Profile
Pages 50 - 51

Available for Corner
and Alcove installation

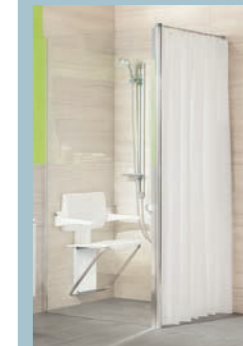

Shower Panels,
Shower
Curtains and
Freestanding
Carer Screens
Pages 52 - 57



Step 4: Personalise

Customise your showering space further by adding a shower seat or bench in a range of colours, modular grab rails to suit your space and a wide selection of thermostatic showers to best fit your requirements.

Shower Seats
Pages 58 - 65



Grab Rails, Hand Rails
& Accessories
Pages 66 - 71



Boston Comfort & Safety Range
Pages 72 - 73



Mixer Showers
Page 76



Electric
Showers
Pages 77 - 79



Showers &
Waste Pump
Kits
Pages 80 - 83



Toilets and Bathroom
Accessories
Pages 84 - 87

Creating 100% level-access on concrete and wooden floors

Commonly known as wetroom trays or wetroom floor formers, these products act as floorboard replacements with a pre-formed gradient to a square drainage point which allows for the creation of a level-access showering space. Wetroom floor formers are then covered in vinyl flooring.

Level-Dec EasyFit

Pages 12 - 15

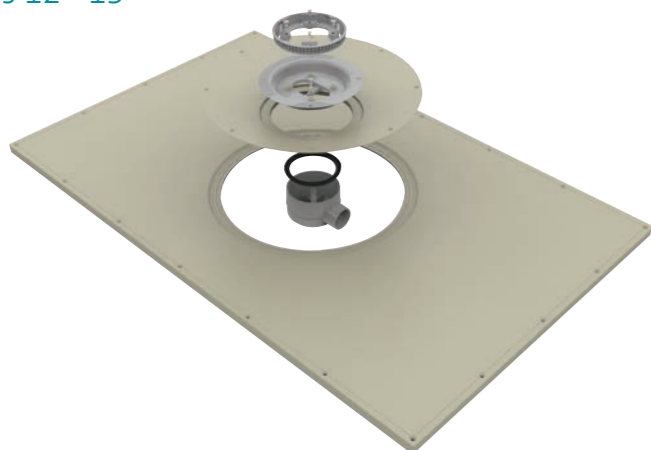

Level-Grade

Pages 16 - 17

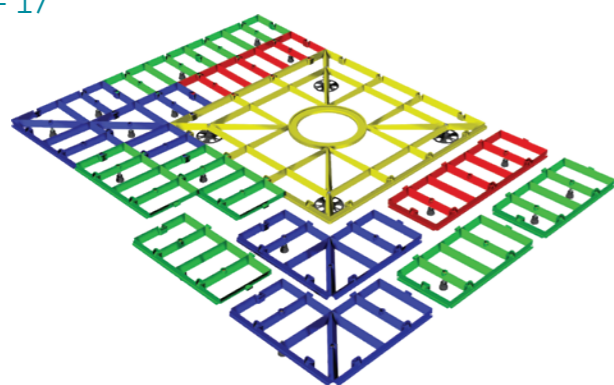

For advice and support on any of our products, call our Technical team on 01460 256080 or visit www.impeyshowers.com

Wetroom Floor Formers

Level-Dec EasyFit

A product specifically designed for vinyl installations

Created by Impey, our patented, Level-Dec EasyFit floor former has continually developed and evolved as a product, and consistently resulted in an improved offering. A product designed to be easier to install and service, and care for the vinyl overtime - providing a longer lasting wetroom.

Level-Dec EasyFit wetroom floor formers are the easiest and most reliable way to create the gradient for efficient drainage in a wetroom floor.



Lifetime Guarantee details on Page 94



Made in the UK. See Pages 4 - 7

- Ideal for wooden or concrete floors
- Quick and easiest former to install on the market
- No under boarding required*
- Easy to cut with a standard handsaw to fit your exact space requirements
- Easy to drill to provide additional screw fixing holes

*For joists under 415mm centre to centre spacing

4 gradients leading to the drain

1:40 gradient across the whole surface down to the drain

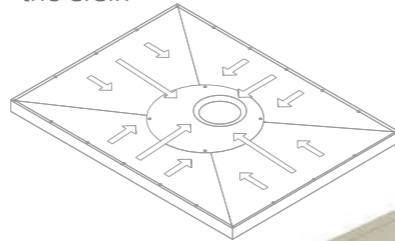

Supplied with a UTVG01/H vinyl floor gully horizontal outlet as standard

Alternative drainage options available. See Page 39



Award-winning 360° rotating drain

Makes installation even easier - the drainage point can be adjusted to avoid any joists and assist in linking up to existing drainage

Patented design. Patent number: GB 2 431 341.



22mm thick

The overall thickness is the same depth as the most commonly used flooring materials providing a level-access finish

22mm

Strong and rigid design

The underside spoke pattern provides increased rigidity to the structure of the floor former allowing it to support up to 300kg

Registered design.

EU Registration number 001 377 002.

001 346 621.



View Level-Dec EasyFit installation video

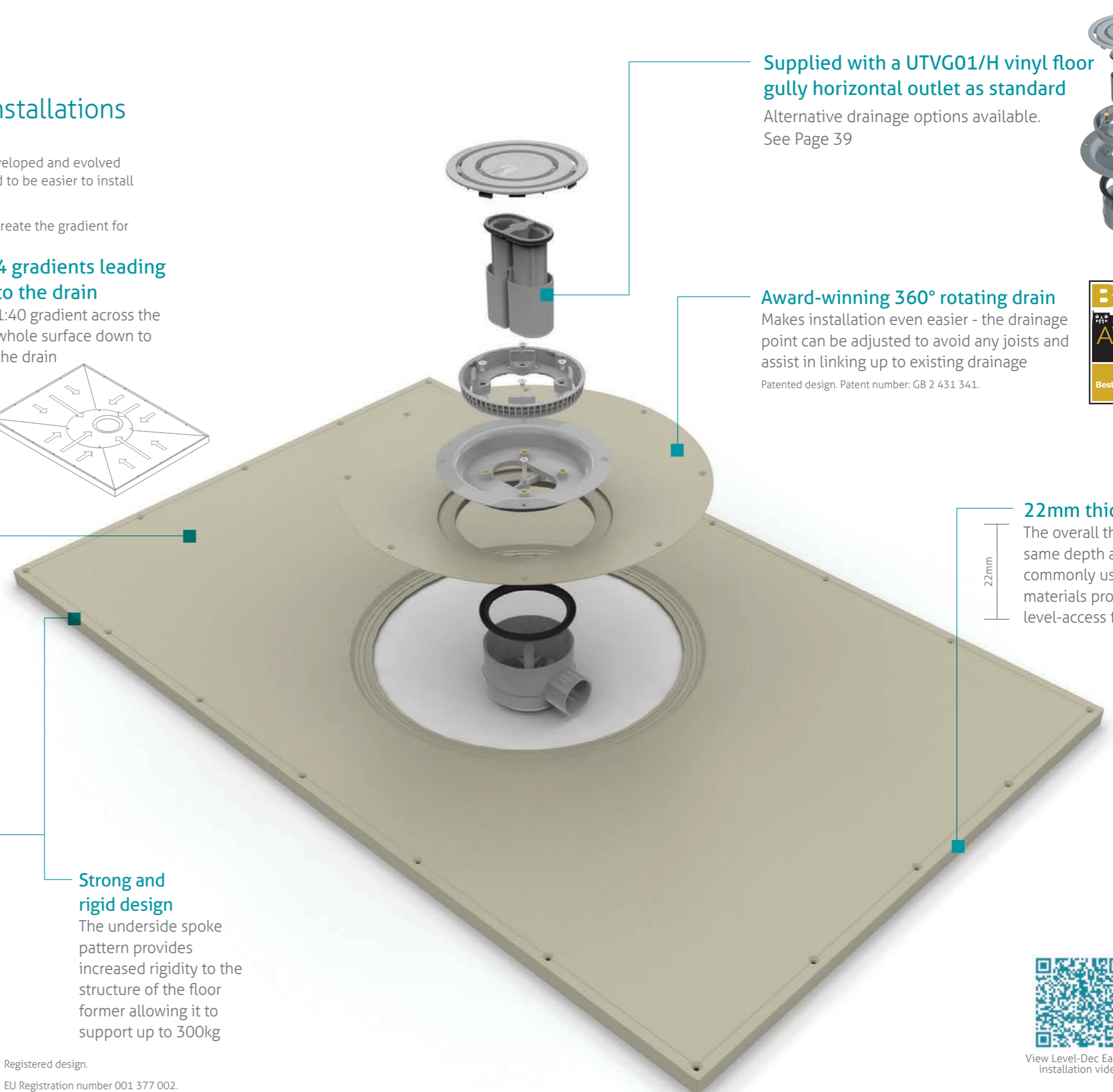
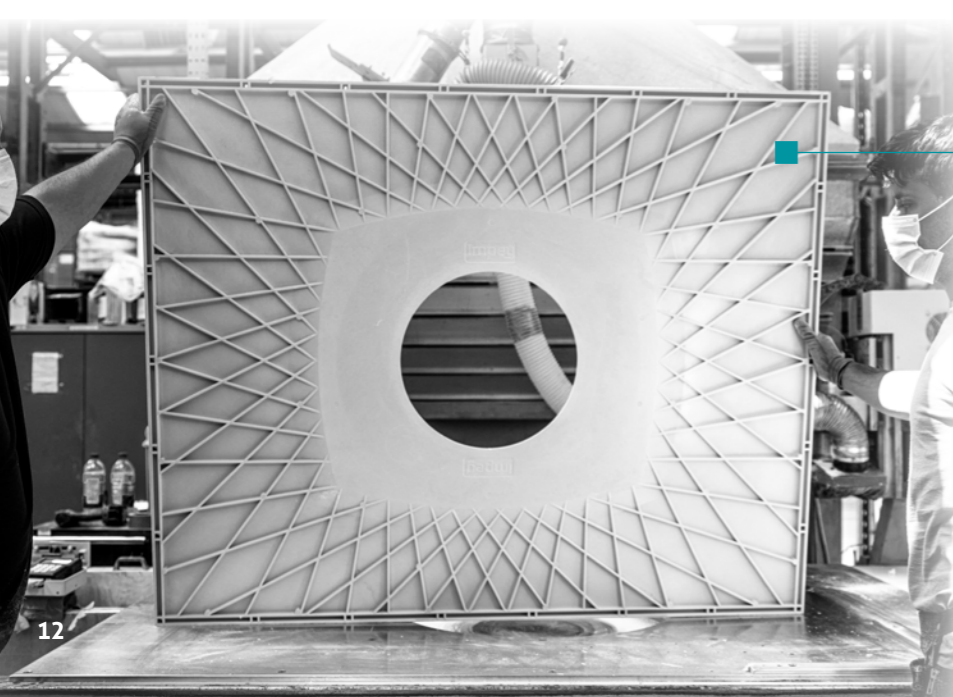

Level-Dec EasyFit

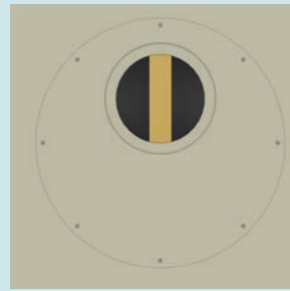

Revolutionary 360° rotating drain by Impey

The Level-EasyFit rotating drain plate can spin 360° to any position to avoid all underfloor wetroom obstructions such as joists.

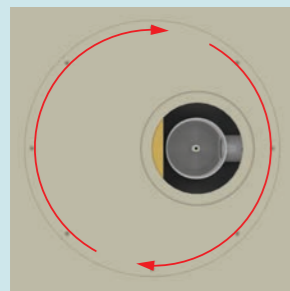

Simply place the Level-Dec EasyFit where it will be installed and if the drain aperture interferes with a joist, just rotate the centre section until it is clear and fit the trap.

Making installation even easier.

- No under boarding required.
- The location of joists within timber floors no longer presents a problem, because the Level-Dec EasyFit includes a revolutionary drainage feature that allows the installer to rotate the drainage point through 360° to any position in order to avoid the joist, standard joist spacing is 415mm.
- If you need to trim or cut to avoid an obstruction it can be cut with a universal hand saw and drilled to provide additional screw fixing holes.

All Level-Decs are 22mm thick at the outer rim to be the same depth as most commonly used flooring materials. Supplied with a UTVG01/H Vinyl Floor Gully Horizontal Outlet as standard. For alternative drainage see Page 39.



All sizes and measurements are shown in mm

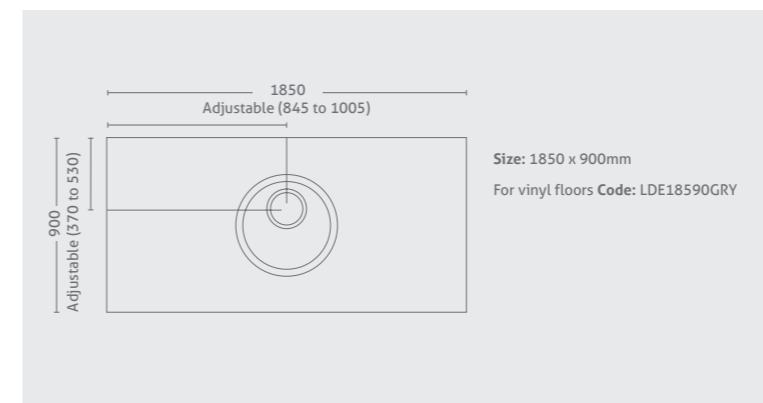
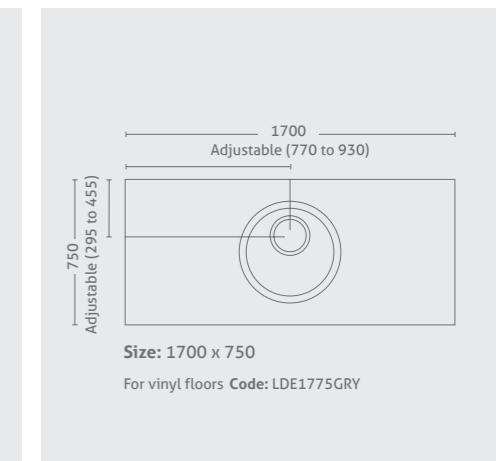
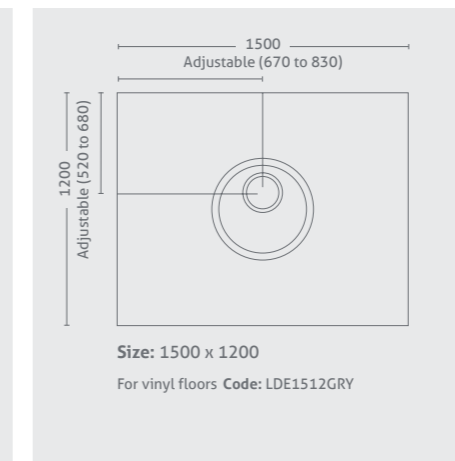
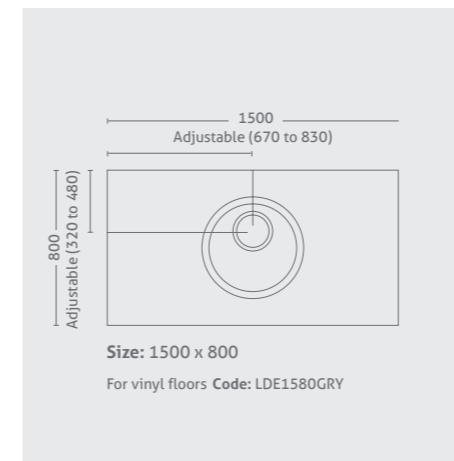
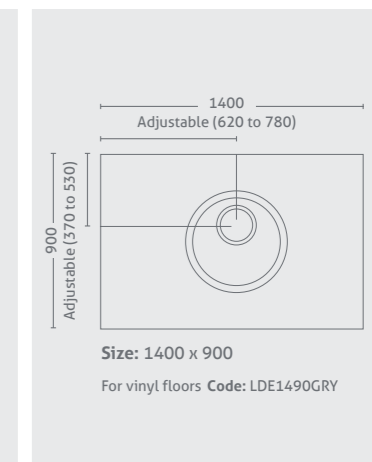
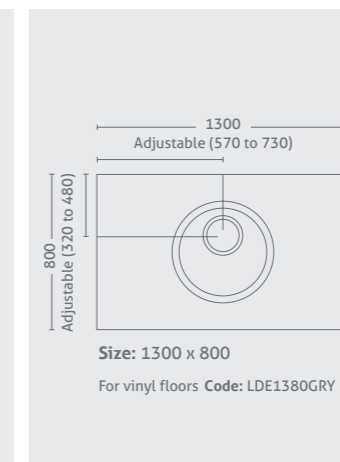
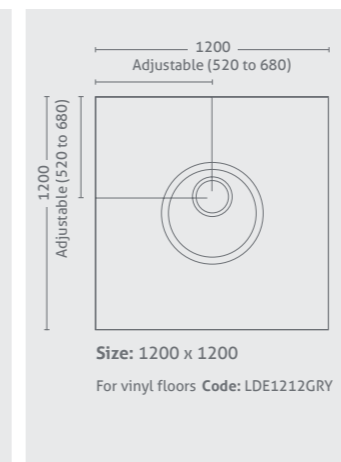
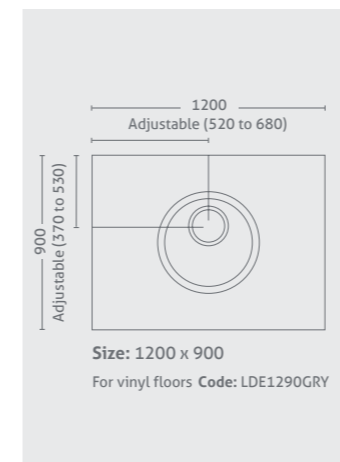
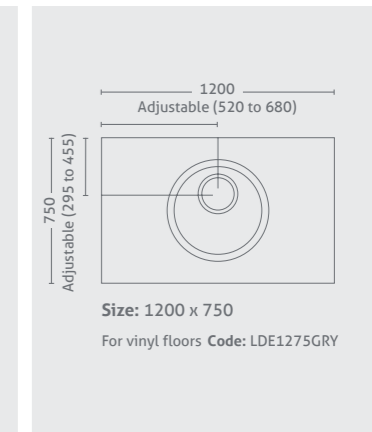
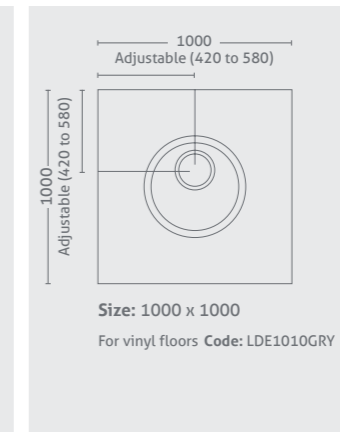
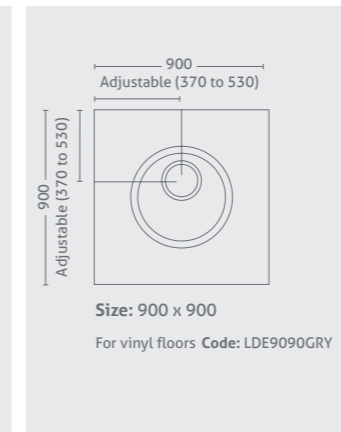
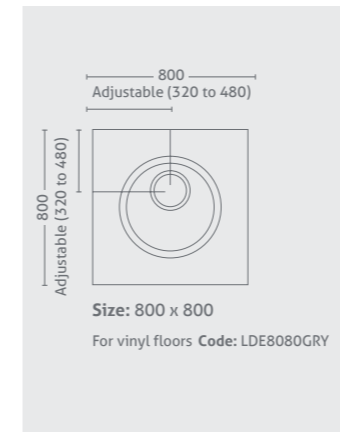

Optional chrome top

See Floor and Door Options on Pages 88 - 93 for a wetroom



View Level-Dec EasyFit installation video

Wetroom Floor Formers

Level-Grade

Colour coded modular sections

Level-Grade provides a quick and easy way of creating the perfect wetroom floor gradient for concrete solid floors.

Colour coded modular sections quickly click together to form a matrix that you simply fill with screed.

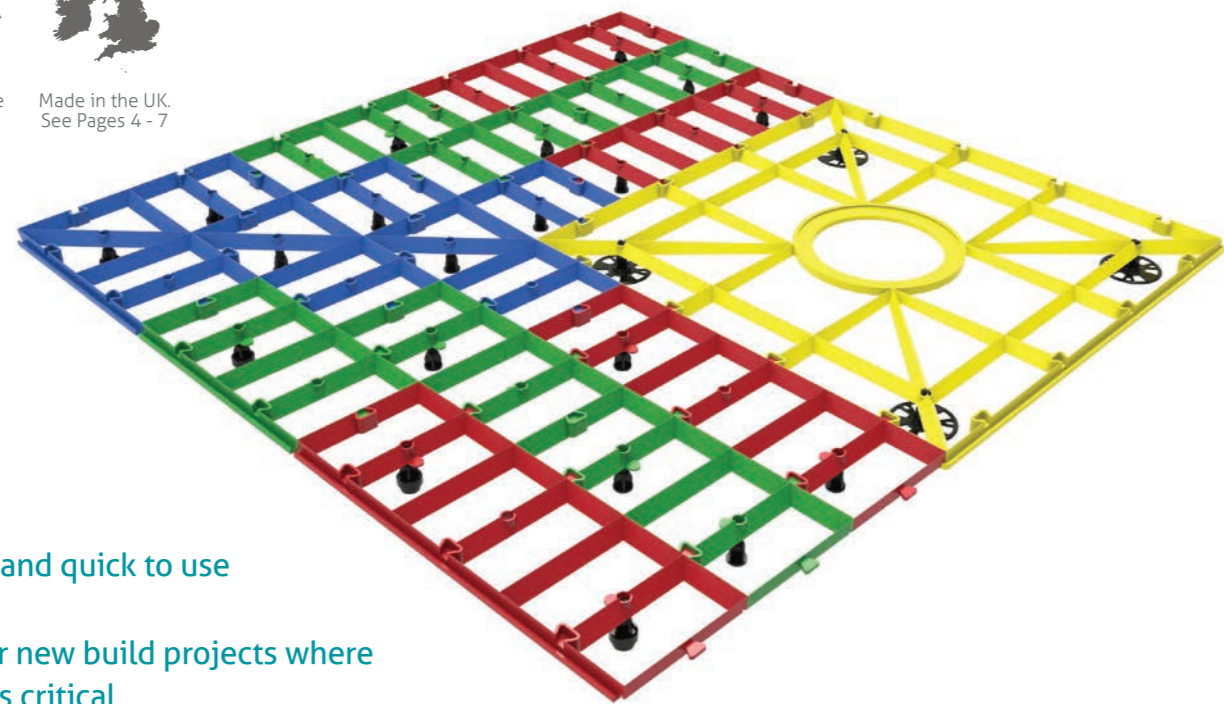
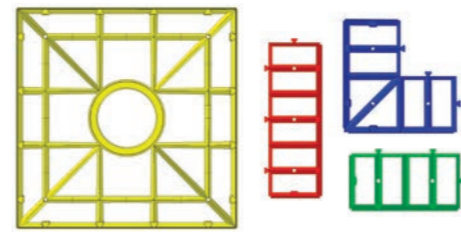



- Precise and quick to use
- Ideal for new build projects where timing is critical
- Guarantees the perfect wetroom floor gradient every time
- Eliminates any chance of water pooling
- Available in 8 standard sizes
- Supplied with a UTVG01/H vinyl floor gully horizontal outlet as standard

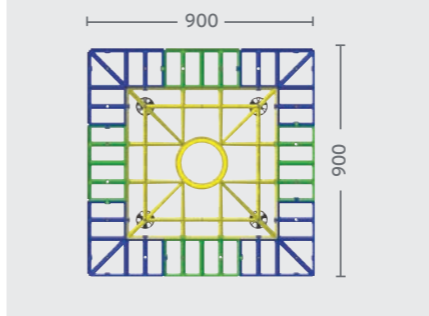
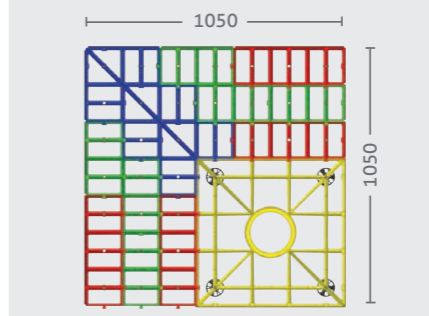
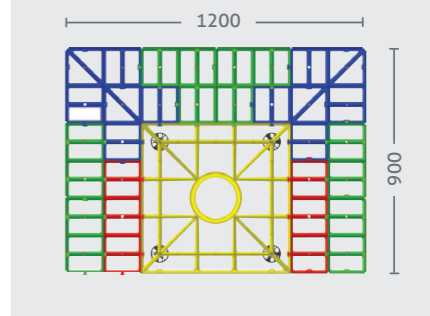
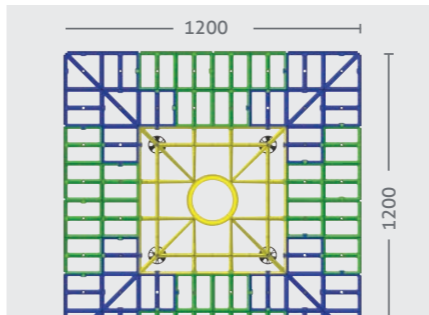
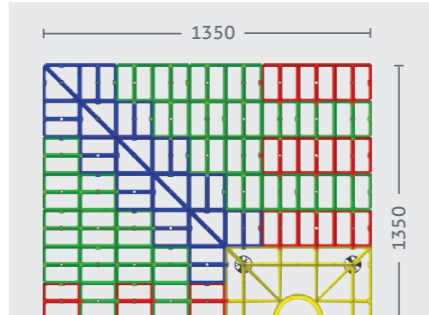
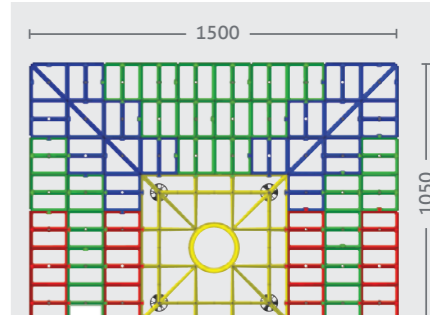
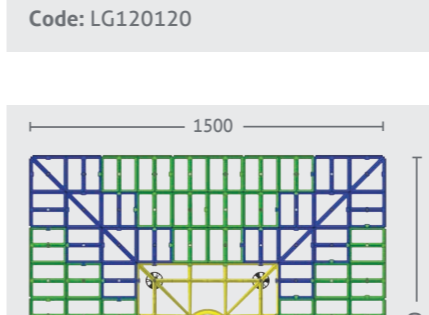
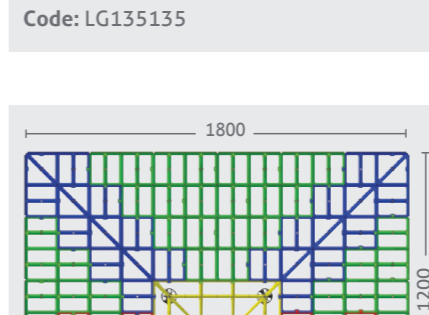

When installing, please refer to the fitting instructions, which are included in the pack.

Level-Grade is available in 8 standard sizes.

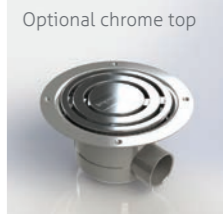
 <p>Size: 900 x 900mm Code: LG9090</p>	 <p>Size: 1050 x 1050mm Code: LG105105</p>	 <p>Size: 1200 x 900mm Code: LG12090</p>
 <p>Size: 1200 x 1200mm Code: LG120120</p>	 <p>Size: 1350 x 1350mm Code: LG135135</p>	 <p>Size: 1500 x 1050mm Code: LG150105</p>
 <p>Size: 1500 x 1500mm Code: LG150150</p>	 <p>Size: 1800 x 1200mm Code: LG180120</p>	 <p>UTVG01/H supplied as standard</p> <p>Alternative drainage options available. See Page 39</p>  <p>Optional chrome top</p>

For advice and support on any of our products, call our Technical team on 01460 256080 or visit www.impeyshowers.com



For unbreachable floors

We offer two dedicated shower tray solutions for installing on unbreachable floors. Our Radiate and Mendip models are supplied with dedicated waste fittings within the height of the tray.

Our Radiate range is only 40mm in height and has been designed with integrated pumped drainage whereas our Mendip range is 100mm in height and features a gravity drain.

Both trays are supplied with our high performance tile upstand waterproofing membrane, providing a guaranteed seamless link between tray and tile.

All Shower Trays come complete with a high quality waste fitting.

Radiate



Pages 20 - 23

Mendip



Pages 24 - 27



For advice and support on any of our products, call our Technical team on 01460 256080 or visit www.impeyshowers.com

Shower Trays

Radiate

Radiate has been specifically designed for situations where gravity drainage is not possible

Radiate instantly solves the problem of fitting shower trays on unbreachable floors with this pumped solution. A Radiate Shower Tray can be installed within high-rise developments and is ideally suited for use with an electric shower.

CE CE Tested complies with BS EN 14527

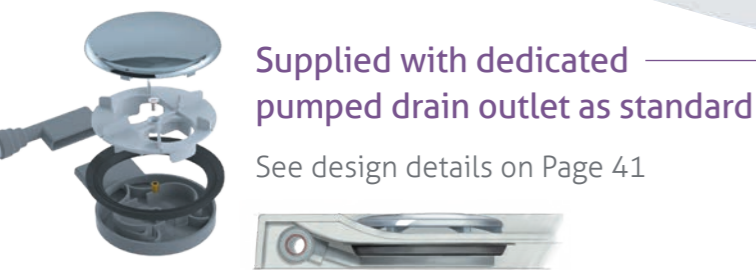

- Quick and easy to install
- Reduced slip, matte finish
- Self-adhesive tile upstand included. Guarantees a watertight seal to wall tiling
- Available in 14 sizes including 2 bath replacement trays
- Easy to clean surface and gully
- Acoustically tuned quiet waste
Advanced ultra quiet drainage
- Designed specifically for pumped drainage
- Designed to work with Whale Switch Connect, Direct Connect and Instant Match waste pumps
- We'd recommend fitting alongside our market leading folding/sliding half height shower doors and glass screens

Flow rate for all Radiate tray sizes is max 8.5 l/min**

Access friendly
Only 40mm high and with compatible ramps available.
Low enough to offer easy access to those with limited mobility into the showering area

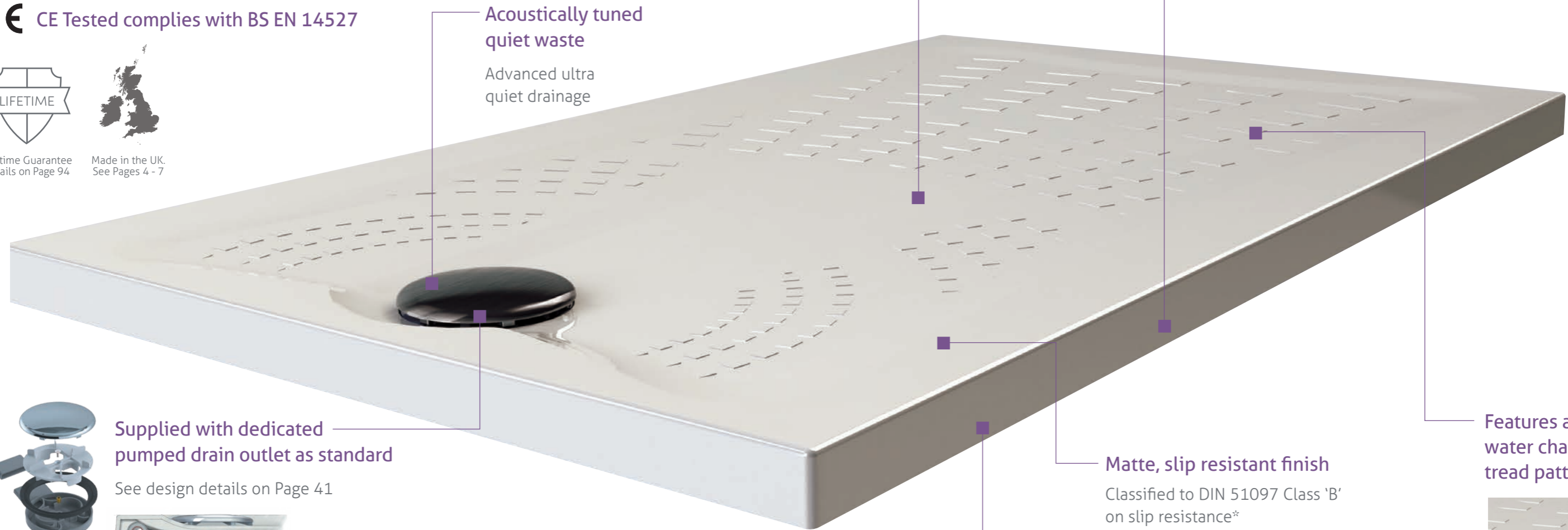

Matte, slip resistant finish
Classified to DIN 51097 Class 'B' on slip resistance*

Features a unique water channelling tread pattern



Exit pipework from any side of the tray

Multiple waste outlet locations, within the height of the tray

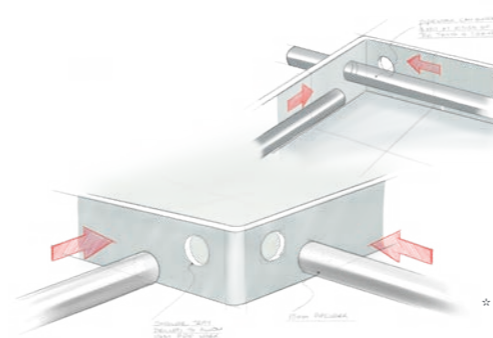

* DIN 51097:1992 Determination of anti-slip properties; wet loaded barefoot areas; walking method; ramp test
** 11 l/min if used as gravity waste

Shower Trays

Radiate

Radiate delivers everything you're looking for to solve all the problems associated with unbreachable floors.

The pumped waste fitting, concealed perfectly within the underside of the tray, ensures that any water draining to the gully is quickly and efficiently fed to the waste pump, with a maximum flow rate of 11 l/m with a gravity waste, 8.5 l/m with the provided pump waste.

The tray features a unique water channelling tread pattern which has a reduced slip anti-shine surface. Classified to DIN 51097 Class 'B' on slip resistance*, Radiate sets a new level of care and design.

It's ideal for multi-storey developments and is compatible with pumped waste options including Whale Switch Connect, Direct Connect and Instant Match waste pumps.

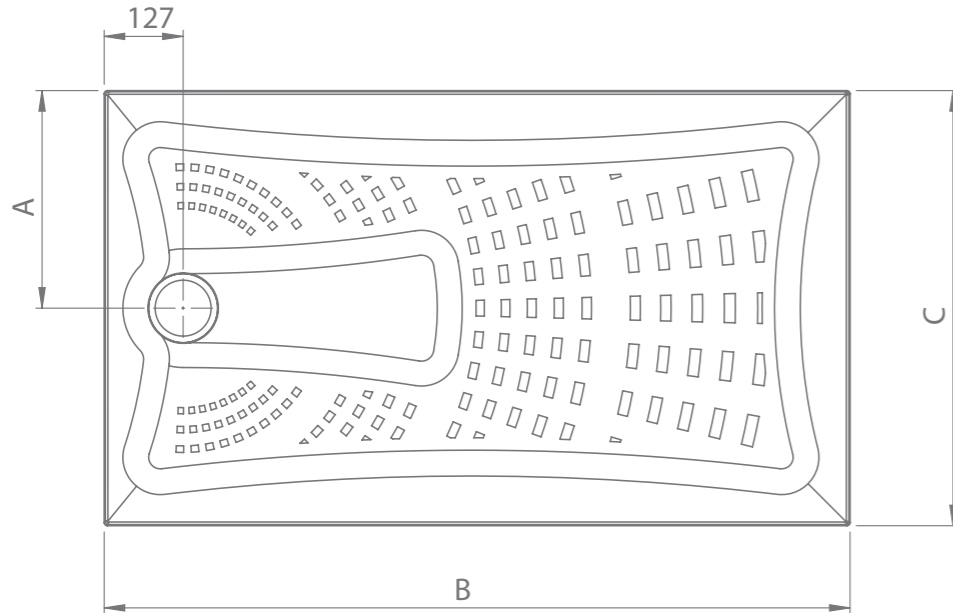

At 40mm high, and with optional ramps, it is low enough to offer easy access to those with limited mobility into the showering area

Radiate sizes and codes

Code	Size (mm)	Dimensions (mm)
RDT9090/P	900 x 900	(A)450 / (B)900 / (C)900
RDT100100/P	1000 x 1000	(A)500 / (B)1000 / (C)1000
RDT12070/P	1200 x 700	(A)350 / (B)1200 / (C)700
RDT12080/P	1200 x 800	(A)400 / (B)1200 / (C)800
RDT12090/P	1200 x 900	(A)450 / (B)1200 / (C)900
RDT13070/P	1300 x 700	(A)350 / (B)1300 / (C)700
RDT13080/P	1300 x 800	(A)400 / (B)1300 / (C)800
RDT14070/P	1400 x 700	(A)350 / (B)1400 / (C)700
RDT14080/P	1400 x 800	(A)400 / (B)1400 / (C)800
RDT14090/P	1400 x 900	(A)450 / (B)1400 / (C)900
RDT15070/P	1500 x 700	(A)350 / (B)1500 / (C)700
RDT15080/P	1500 x 800	(A)400 / (B)1500 / (C)800
RDT17070/P	1700 x 700	(A)350 / (B)1700 / (C)700
RDT17080/P	1700 x 800	(A)400 / (B)1700 / (C)800

Ramp Kits

Code	Description
RDRKIT	Ramp Kit
RDRCS	Ramp Corner Section

Radiate is supplied with a pumped drain as standard.

See Floor and Door Options on Pages 88 - 93 for a shower tray

Radiate - Bath Replacement Tray

The ideal solution for bath replacement



Radiate Bath Replacement Trays have been designed so that they can be cut down to fit a wall to wall space where a bath was previously installed.

A conventional multipurpose handsaw can be used to cut the shower tray.

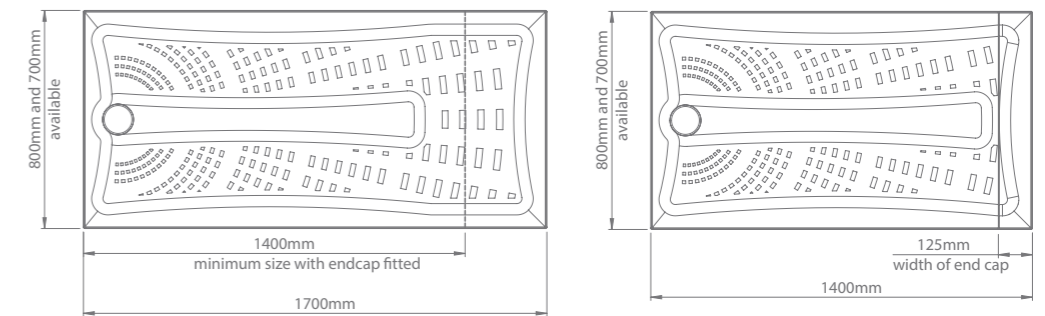

When measuring and cutting the tray please allow for the end cap. See illustration below.

Supplied with dedicated pumped drain outlet
Details on Page 41



Self-Adhesive Tiling Upstand

Supplied with high performance tile upstand waterproofing membrane, providing a guaranteed seamless link between tray and tile

Waterproof Self Adhesive Tiling Upstand (3.5m roll - 120mm wide)

Code: US12350

LIFETIME

Lifetime Guarantee details on Page 94

Made in the UK. See Pages 4 - 7

See Floor and Door Options on Pages 88 - 93 for a bath replacement tray

Mendip

Gravity solution for unbreachable floors

Designed for installations where the floor cannot be breached, as is often the case in situations, such as multi-storey apartments. The design of the Mendip Shower Tray portfolio means it is fully self-supporting, so there is no need to bed it down. The waste fitting is housed beneath the tray, which is 100mm high. A sloping Access Ramp and 50mm Half Step are available to provide easier access.

CE CE Tested complies with BS EN 14527



Lifetime Guarantee details on Page 94



Made in the UK. See Pages 4 - 7



Slip resistance classified to DIN 51097 Class 'A'

Classified to DIN 51097 Class 'A' on slip resistance*

Highly robust construction

Inspection cover

Tray depth of 100mm

Actual height 100mm

Compatible with a sloping Access Ramp or a 50mm Half Step to provide easier access

Supplied with a factory fitted waste trap with swivel outlet for drainage positioning

50mm water seal compliant with building regulations



*DIN 51097:1992 Determination of anti-slip properties; wet loaded barefoot areas; walking method; ramp test

Shower Trays

Mendip

Shower Tray with above floor drainage

The Mendip range offers 7 sizes including a Bath Replacement Tray. Flow rate 8-10 l/m depending on the size of shower tray. Multiple waste outlet locations, within the height of the tray. Exit pipework from any side of the tray.

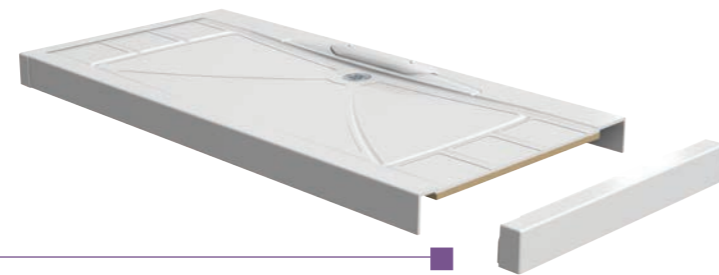

Cut to length version available with 2 end caps supplied



Size: 900 x 900mm
Code: MEN501/C



Size: 1000 x 1000mm
Code: MEN601/C



Size: 1250 x 710mm
Code: MEN101/C



Size: 1250 x 830mm
Code: MEN201/C



Size: 1500 x 710mm
Code: MEN301/C



Size: 1500 x 830mm
Code: MEN401/C



Size: 1850 x 710mm
Code: MEN701/C (cut to length version with two end caps supplied - trim with saw)

Available in a range of sizes:

900 x 900mm	Code: MEN501/C
1000 x 1000mm	Code: MEN601/C
1250 x 710mm	Code: MEN101/C
1250 x 830mm	Code: MEN201/C
1500 x 710mm	Code: MEN301/C
1500 x 830mm	Code: MEN401/C
1850 x 710mm	Code: MEN701/C

Access Ramp



Size: 900 x 400mm
Code: MEN/R01

50mm Half Step



Size: 720 x 300mm
Code: MEN/P01



All Mendip trays include a factory fitted waste trap
The compact above ground trap has a swivel outlet for drainage positioning. It has a 40mm outlet and a 50mm water seal. Designed to be used with single instantaneous feed with electric showers and medium flow mixer valves.



Self-Adhesive Tiling Upstand

Supplied with high performance tile upstand waterproofing membrane, providing a guaranteed seamless link between tray and tile

Waterproof Self Adhesive Tiling Upstand (3.5m roll - 120mm wide)

Code: US12350



Lifetime Guarantee details on Page 94



Made in the UK. See Pages 4 - 7

See Floor and Door Options on Pages 88 - 93 for a shower tray



For advice and support on any of our products, call our Technical team on 01460 256080 or visit www.impeyshowers.com

Low Level Shower Trays

From as low as 24mm

We offer a wide range of shower trays to suit all types of applications. Our Low Level Shower Trays are built to accommodate both gravity and pumped drainage whilst also providing easy access with compatible ramps.

Mantis

Pages 30 - 33



Slimline

Pages 34 - 37



For advice and support on any of our products, call our Technical team on 01460 256080 or visit www.impeyshowers.com

Low Level Shower Trays

Mantis

The only 24mm high shower tray on the market

At just 24mm in height, the Mantis Shower Tray delivers a significant advancement in low level showering specification. Tested in accordance with the same DIN 51097* Class 'B' high slip safety rating as our Radiate Shower Tray.

CE CE Tested complies with BS EN 14527



Lifetime Guarantee details on Page 94



Made in the UK. See Pages 4 - 7

End centre drain position

Specially designed water channelling system

Matte finish for additional grip

Designed to be a functional and aesthetic tread pattern

Slip resistance surface classified to DIN 51097 Class 'B'

Classified to DIN 51097 Class 'B' on slip resistance*

No ramp required

At only 24mm, this tray can be accessed easily by wheelchair users

Actual height 24mm

24mm low level-access tray

- Step in height of only 24mm - only shower tray on the market of this height

- 12 sizes in total including 2 bath replacement trays

- Flow rate: 11 l/min

- Easy clean surface

- Perfect for use with electric showers

- Unhanded tray

- Versatile installation - can be recessed into the floor to provide complete level-access

All Mantis trays come supplied with tiling upstand and waste



All supplied with 90mm trap.
Code: IMOR/HKIT
Alternatives available see Page 40



Self-Adhesive Tiling Upstand

Supplied with high performance tile upstand waterproofing membrane, providing a guaranteed seamless link between tray and tile

Waterproof Self Adhesive Tiling Upstand (3.5m roll - 120mm wide)

Code: US12350

*DIN 51097:1992 Determination of anti-slip properties; wet loaded barefoot areas; walking method; ramp test.

Low Level Shower Trays

Mantis

The Mantis Shower Tray is the industry's first ultra slim shower tray

Developed after direct consultation with Occupational Therapists and Contractors, the Mantis Shower Tray offers the perfect solution in situations where a floor former cannot be installed. Mantis can be installed above or below ground to suit specific locations, has a flow rate of 11 litres per minute, due to its water channeling tread pattern, and is supplied with a tile upstand and compatible gravity drainage.

Similar to Radiate, Mantis has been designed with an easy to clean, slip resistant matte finish, that qualifies to DIN 51097 Class 'B' on slip resistance*. This provides an increased grip for users in wet, soapy conditions, compared to more traditional shower trays. Mantis is available in 12 sizes including 2 bath replacement sizes which can also be cut down to a minimum length of 1400mm supplied end caps to ensure a perfect fit. Bedding down of the tray is recommended.

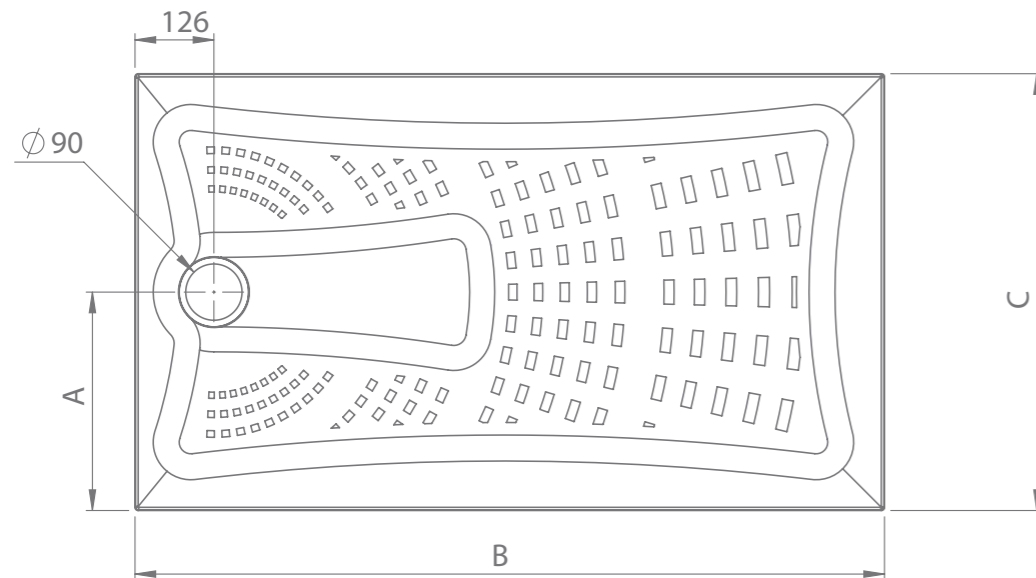

Mantis sizes and codes

Code	Size (mm)	Dimensions (mm)	(A) / (B) / (C)
MTS9090	900 x 900	(A)449 / (B)900 / (C)900	
MTS100100	1000 x 1000	(A)499 / (B)1000 / (C)1000	
MTS12070	1200 x 700	(A)349 / (B)1200 / (C)700	
MTS12080	1200 x 800	(A)399 / (B)1200 / (C)800	
MTS13070	1300 x 700	(A)349 / (B)1300 / (C)700	
MTS13080	1300 x 800	(A)399 / (B)1300 / (C)800	
MTS14070	1400 x 700	(A)349 / (B)1400 / (C)700	
MTS14080	1400 x 800	(A)399 / (B)1400 / (C)800	
MTS15070	1500 x 700	(A)349 / (B)1500 / (C)700	
MTS15080	1500 x 800	(A)399 / (B)1500 / (C)800	
MTS17070	1700 x 700	(A)349 / (B)1700 / (C)700	
MTS17080	1700 x 800	(A)399 / (B)1700 / (C)800	

Mantis is supplied with horizontal outlet drain as standard.

See Floor and Door Options on Pages 88 - 93 for a shower tray

*DIN 51097:1992 Determination of anti-slip properties; wet loaded barefoot areas; walking method; ramp test.

Mantis - Bath Replacement Tray



Mantis Bath Replacement Trays have been designed so that they can be cut down to fit a wall to wall space where a bath was previously installed.

A conventional multi purpose handsaw can be used to cut the shower tray.

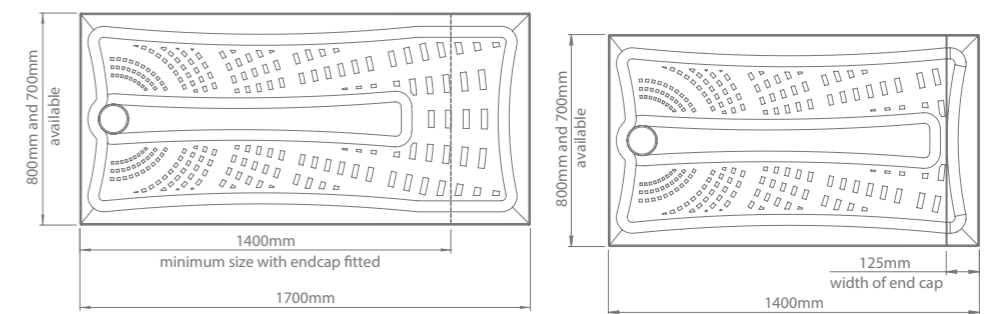

When measuring and cutting the tray please allow for the end cap

All Mantis trays come supplied with tiling upstand and waste



All supplied with 90mm trap.
Code: IMOR/HKIT
Alternatives available see Page 40



Self-Adhesive Tiling Upstand

Supplied with high performance tile upstand waterproofing membrane, providing a guaranteed seamless link between tray and tile

Waterproof Self Adhesive Tiling Upstand (3.5m roll - 120mm wide)

Code: US12350



Lifetime Guarantee details on Page 94



Made in the UK. See Pages 4 - 7

See Floor and Door Options on Pages 88 - 93 for a bath replacement tray

Low Level Shower Trays

Slimline

Our most versatile high performance shower tray

The 35mm high Slimline Shower Tray incorporates an ergonomic slip resistant design with industry leading flow rates of up to 36 litres per minute.

The tray can be recessed into the floor or fitted with a ramp around the entire perimeter for easier access.

CE CE Tested complies with BS EN 14527



Lifetime Guarantee details on Page 94

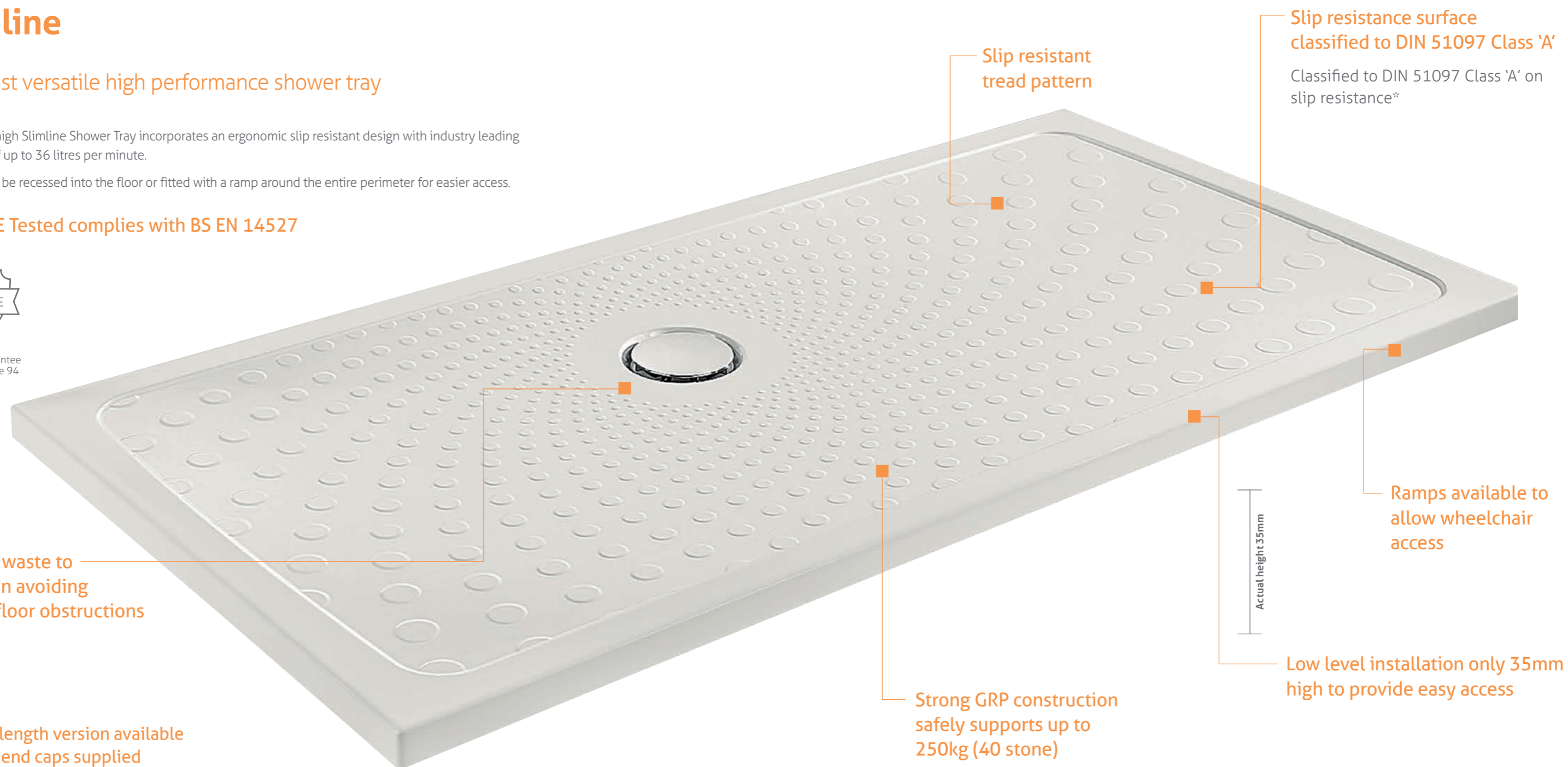

Offset waste to assist in avoiding underfloor obstructions

Slip resistant tread pattern

Slip resistance surface classified to DIN 51097 Class 'A'
Classified to DIN 51097 Class 'A' on slip resistance*

Ramps available to allow wheelchair access

Actual height 35mm

Low level installation only 35mm high to provide easy access

Strong GRP construction safely supports up to 250kg (40 stone)

- Cut to length version available with 2 end caps supplied
- Maximum flow rate of up to 36 litres per minute
- Available in 9 sizes + 3 bath replacement trays
- Versatile installation - can be recessed into the floor to provide 100% level-access
- Compatible with all Impey shower doors and glass panels

- Easy clean surface
- Non-handed design
- Compatible with Gravity, Pumped and Slimline drainage options
- Service ducting available to conceal pipework making installation easier as there is no need to chase out the walls or floors

All Slimline trays come supplied with tiling upstand and waste



All supplied with 90mm trap.
Code: IMOR/HKIT
Alternatives available, see Page 40



Self-Adhesive Tiling Upstand
Supplied with high performance tile upstand waterproofing membrane, providing a guaranteed seamless link between tray and tile
Waterproof Self Adhesive Tiling Upstand (3.5m roll - 120mm wide)
Code: US12350

*DIN 51097:1992 Determination of anti-slip properties; wet loaded barefoot areas; walking method; ramp test.

Low Level Shower Trays

Slimline

This modern, stylish slimline tray from Impey offers a low-level installation at only 35mm high.

They can also be recessed into the floor or fitted with a ramp around the entire perimeter for easier access. Robust GRP construction will support up to 250kg (40 stone). Service ducting to conceal pipe work is available, which makes installation easier by removing the need to chase out the floor or walls.

Flow rate up to 36 litres per minute depending on the size of Shower Tray

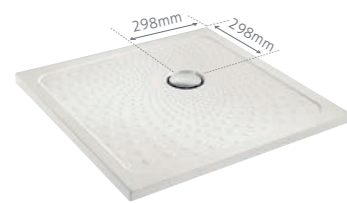

Size: 800 x 800mm
Code: SL358080

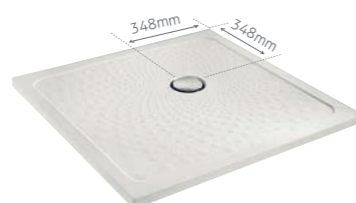

Size: 900 x 900mm
Code: SL359090

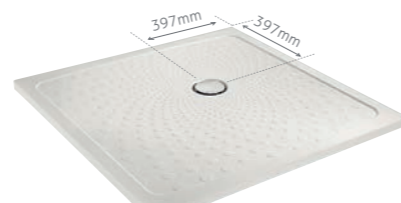

Size: 1000 x 1000mm
Code: SL35100100

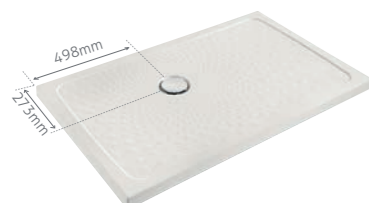

Size: 1200 x 750mm
Code: SL3512075



Size: 1200 x 900mm
Code: SL3512090



Size: 1300 x 700mm
Code: SL3513070



Size: 1300 x 750mm
Code: SL3513075

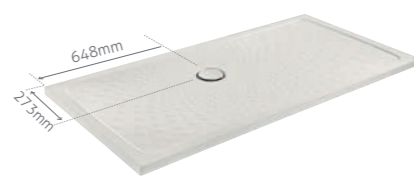

Size: 1500 x 750mm
Code: SL3515075

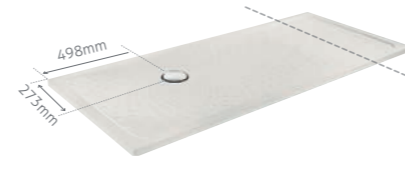

Size: 1700 x 750mm
Code: SL3517075/CWEC
(Can be cut to length. End cap supplied)

Ramp Kit

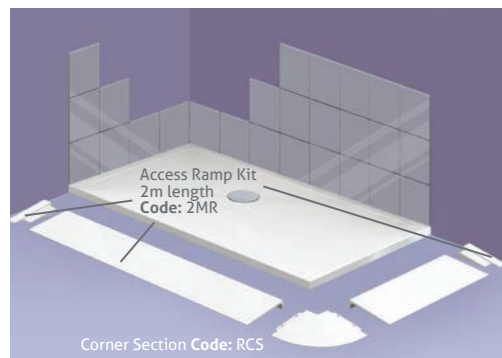

Versatile installation



Can be recessed into floor for level-access

See Floor and Door Options on Pages 88 - 93 for a shower tray

Slimline Bath Replacement Tray



Lifetime Guarantee details on Page 94

These have been specially designed to cover all the sizes required to replace a bath, whilst still offering a low-level installation at only 40mm high.

They can also be recessed into the floor. Robust GRP construction will support up to 250kg (40 stone).

- Features a matte, slip resistant surface
- Flow rate up to 36 litres per minute depending on the size of shower
- Classified to DIN 51097 Class 'B' on slip resistance*

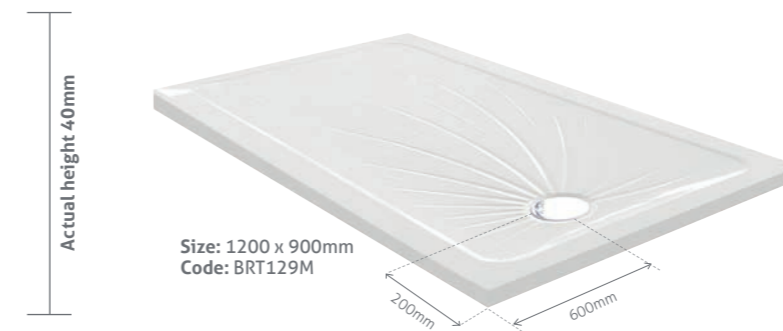

Size: 1200 x 900mm
Code: BRT129M

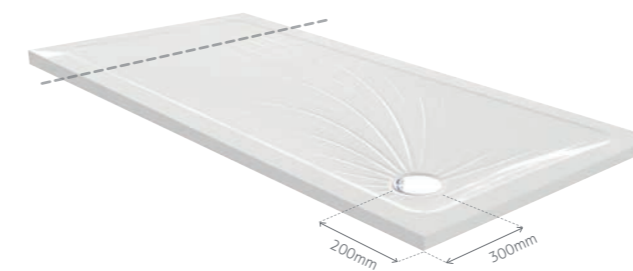

Size: 1700 x 850mm
Code: BRT1785M
(Can be cut to length. End cap supplied separately)
Code (End cap): BRTM/EC85

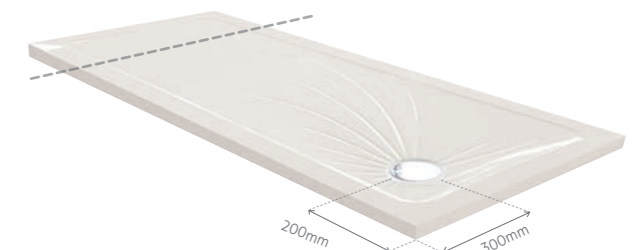

Size: 1700 x 750mm
Code: BRT1775M
(Can be cut to length. End cap supplied separately)
Code (End cap): BRTM/EC75

All Slimline trays come supplied with tiling upstand and waste



All supplied with 90mm trap.
Code: IMOR/HKIT
Alternatives available, see Page 40



Self-Adhesive Tiling Upstand

Supplied with high performance tile upstand waterproofing membrane, providing a guaranteed seamless link between tray and tile

Waterproof Self Adhesive Tiling Upstand (3.5m roll - 120mm wide)

Code: US12350

See Floor and Door Options on Pages 88 - 93 for a bath replacement tray

*DIN 51097:1992 Determination of anti-slip properties; wet loaded barefoot areas; walking method; ramp test.

Drain options available for showering solutions

Drainage is supplied as standard with all Impey floor formers and shower trays. If an alternative is required, we provide solutions for various wetroom spaces and to overcome any limitations. In some situations, a certain drain type will be required due to the existing flooring it is placed in. We offer a range of Gravity, Pumped and Slimline options.

Universal Trap for wetrooms

With grey cover Code: UTVG01/H

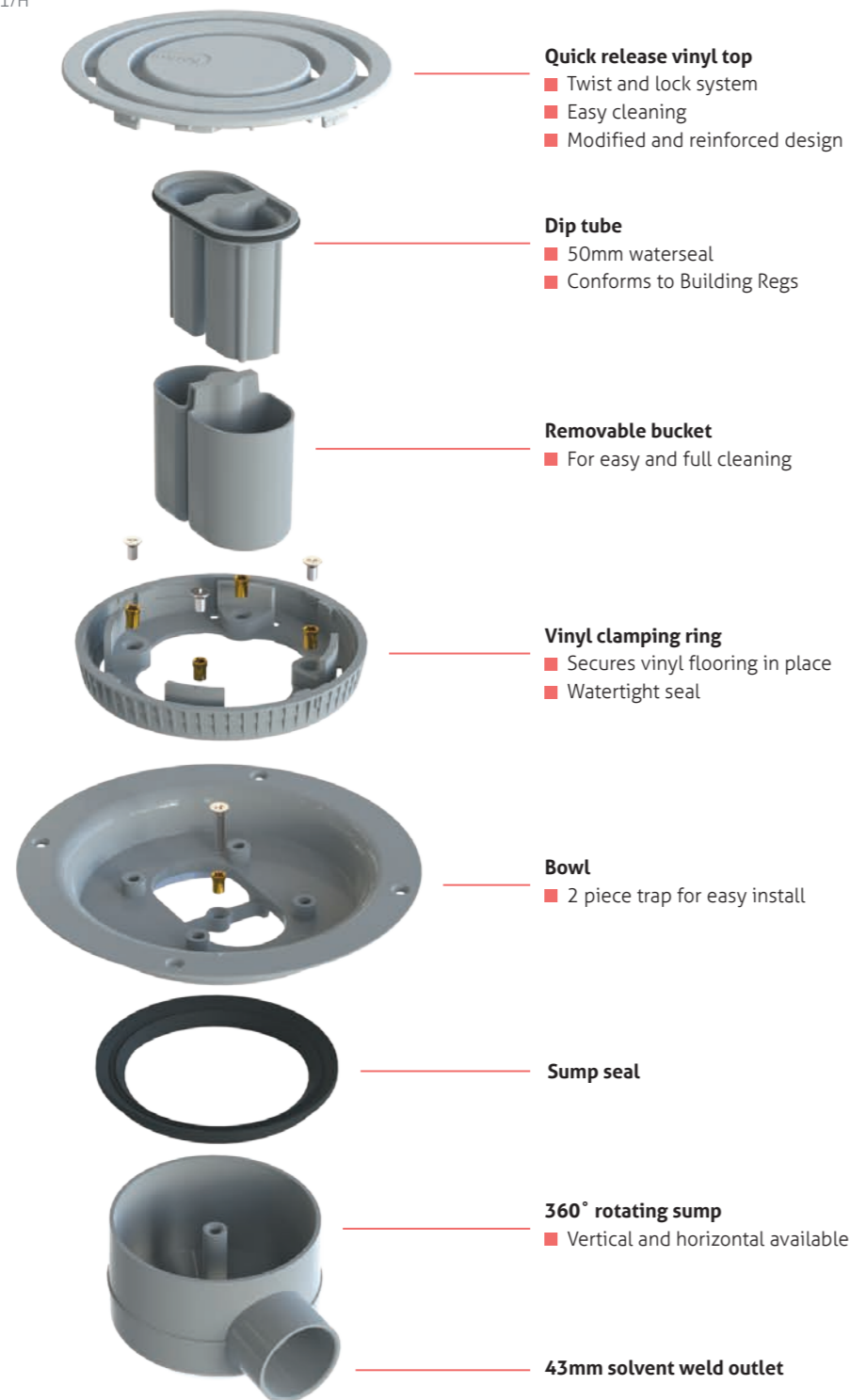

Drainage options for vinyl wetroom floors

All Level-Dec EasyFit and Level-Grade floor formers are supplied with our gravity Horizontal and Vertical outlet, Slimline traps or Pumped gully. Alternative options are available at extra cost. Please specify when ordering.

Horizontal outlet (supplied as standard)

With grey cover Code: UTVG01/H
With chrome cover Code: UTVG01/H (CHROME)



Vertical outlet

With grey cover and clamping ring Code: UTVG01/V
With chrome cover and clamping ring Code: UTVG01/V (CHROME)



Slimline waste

A waterless trap with a removable one way silicone seal
Code: SLW1
Additional charges apply

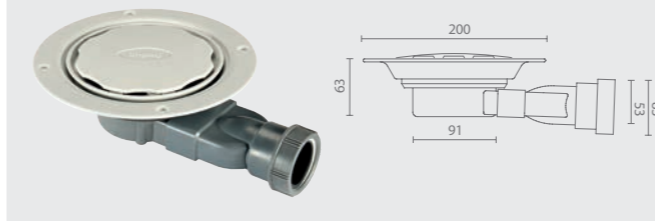

For pumped waste

With grey cover and clamping ring Code: TAD13
With chrome cover and clamping ring Code: TAD3/CP
Additional charges apply

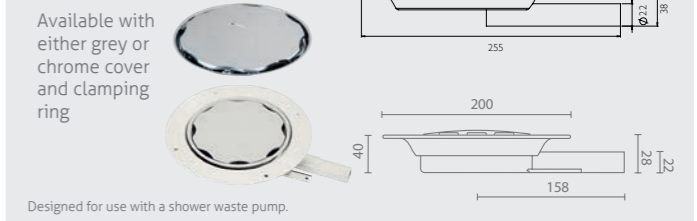

Horizontal outlet

75mm waterseal with a 50mm outlet and a 40mm reducer
Code: TSG1WH
Additional charges apply



Vertical outlet

75mm waterseal with a 110mm outlet and a 50mm reducer
Code: TSG2
Additional charges apply



Drainage options for shower trays

Shower trays that require a gravity waste are supplied as standard with an IMOR/HKIT. Alternatively we can offer other waste outlet types which you can specify when ordering.

Horizontal outlet (supplied as standard)

50mm water seal with a 43mm swivel joint outlet
Code: IMOR/HKIT

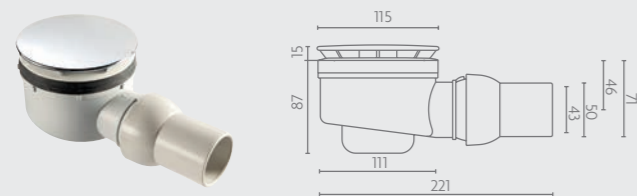

Vertical outlet

50mm water seal
Code: IMOR/VKIT



For pumped waste

Code: IMOR/PKIT

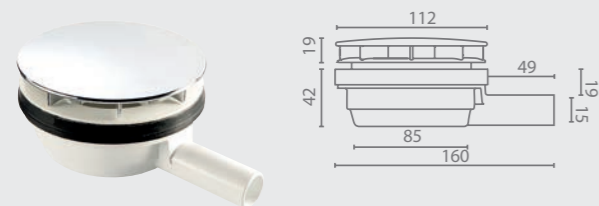

Slimline waste

A waterless trap with a removable one way rubber seal
Code: SLW/TT1

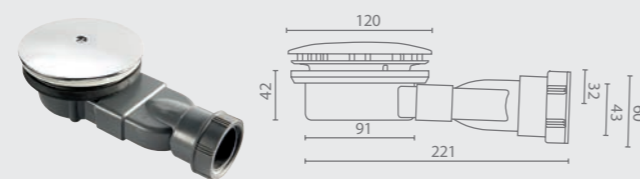

Impey Bath Adapter for Lifetime Home

The Impey Bath Adapter allows you to install a wetroom floor, with a bath above to meet the needs of tenants today, whilst allowing for a simple and economical conversion to a level-access wetroom, to suit future requirements.



Bath Adapter
Compatible with: UTVG01/H

Code: UT/BC

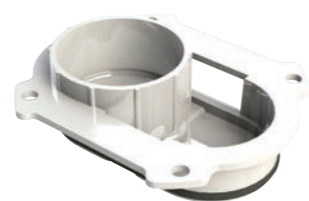

For advice and support on any of our products, call our Technical team on 01460 256080 or visit www.impeyshowers.com

The Design: Radiate Trays with Pumped Drain

Developed by our Research & Development team, our range of Radiate trays provide an advanced ultra-quiet pumped solution for unbreachable floors.

The decision of the 40mm tray means all pipework is situated within the depth of the tray and has been designed to allow the pipework to exit from any side. This ensures the depth needed to install this shower tray and pumped system never needs to exceed the height of the 40mm tray and therefore eliminates the need to work into the flooring. This makes it ideal for high rise developments.

Designed to work with Whale Switch Connect, Direct Connect and Instant Match waste pumps.

Further details on Pumped drainage options on Pages 80 - 83

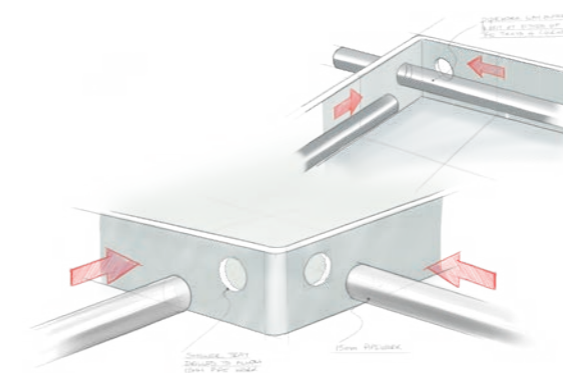

How it works

Due to the gradient and channeled design of the Radiate tray, the water naturally flows down the drain where it falls into a specially designed chamber. With strategically positioned sections, the water then circulates through the two outer paths towards the pumped outlet.

The mouth of the outlet is only 15mm high to ensure it is filled with water when in use, this then minimises the amount of air being drawn into the pump. This innovative design heavily reduces the noise which can incur with standard pumped waste options.

The pump is angled to draw the water in as well as up to the pipework, which is situated higher than the initial chamber. By doing this it avoids any pipework having to be situated below and therefore eliminating the need to recess into the flooring.

More information on Radiate Trays and available sizes on Pages 20 - 23

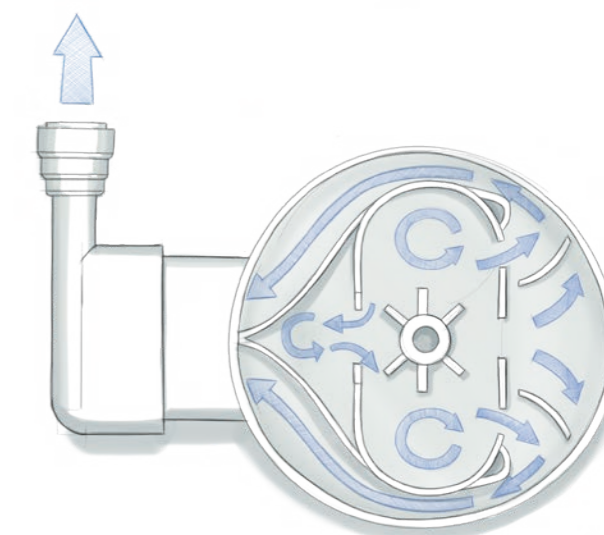
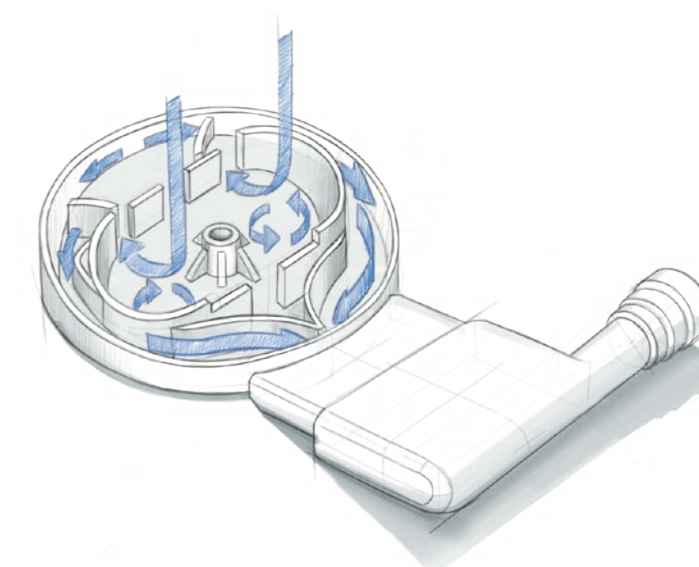
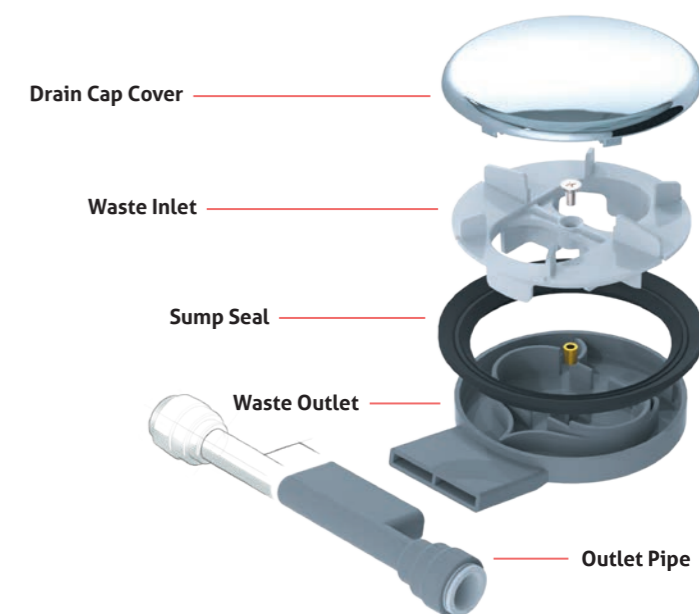

Shower Doors, Panels, Curtains and Screens

A range of options to suit every situation

Our portfolio of Half Height Shower Doors, Bi-Fold Doors, Glass Panels, Curtains and Carer Screens products ensure we can provide with numerous installations in a wetroom and bathroom environment.

Elevate Half Height Doors Pages 46 - 47



Elevate and FreeGlide Half Height Doors are available as Bi-Fold and Sliding options.

FreeGlide Half Height Doors Pages 48 - 49



Double Bi-Fold Doors with Coving Profile Pages 50 - 51

With the addition of our new Coving Profiles, the doors can be installed onto a vinyl floor without a threshold.

The door design makes this the perfect door design when maximum space is advantageous.



Double Bi-Fold Doors can be installed in a corner or an alcove.



Supreme Glass Panel Pages 52 - 55



Curtain Rails and Shower Curtains Pages 56 - 57



Freestanding Carer Screens Page 57



For advice and support on any of our products, call our Technical team on 01460 256080 or visit www.impeyshowers.com

Half Height Shower Doors

Elevate and FreeGlide Designs

Outstanding solutions for every care sector installation

Impey's Half Height Shower Doors set the industry benchmark since 1990 and now they're an even smarter choice to specify.

Designed, developed and manufactured by Impey in the UK, these ranges provide outstanding innovative features for both user and carer and those in the care sector - from Occupational Therapists specifying for private and sheltered homes to Technical Officers looking for quality and affordability when pricing for care homes and new builds.

There is no better Half Height Shower Door.



Lifetime Guarantee details on Page 94
Made in the UK. See Pages 4 - 7

Specifier Benefits

- Available in wide range of options and sizes
- Easy to replace seal and serviceable parts
- Designed and built by Impey
- Special and bespoke sizes available to order
- Unbeatable customer service and technical support
- Door height setting tool supplied as standard to ensure correct clearance for door seals
- Easy fitting - using TigerFix to anchor at the base so there is no drilling required through the vinyl floor or shower tray
- Flexible adjustment for ease of installation
- Average install time of 20 minutes
- Lifetime guarantee

Why choose Impey?

- Designed and manufactured to the highest standards for safety and durability
- Special and bespoke sizes available in both Elevate and FreeGlide
- Solutions to suit every healthcare installation, improving the lives of thousands of people every year
- Impey provide everything you need for a high quality wetroom Installation
- Unbeatable customer service offering order processing and technical support, plus installation training
- Made in the UK

All Elevate and FreeGlide Half Height Doors are designed and manufactured to fit a wetroom, a shower tray or a bath replacement tray. Please follow the guide to help assess the placement of the Half Height Doors.

Half Height Door - handing

When working out whether the area needs a Left Handed or a Right Handed Half Height Door, it is best to refer to the roomset diagram.

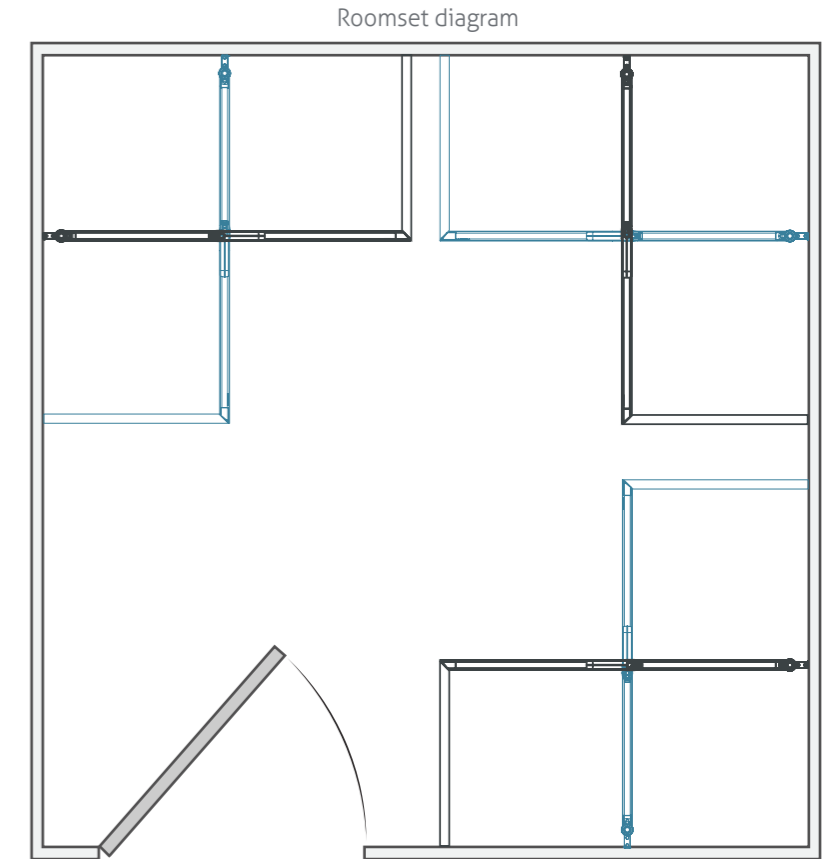
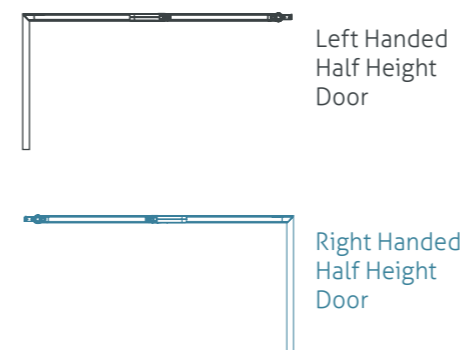

Half Height Door - sizing

Standard
Half Height Doors are manufactured to allow for wall tile, or shower board finishes as standard. Do not make extra deductions for wall finishes when taking measurements.

Special / Bespoke
If the dimensions provided upon ordering are 'Tile-to-Tile', 10mm is added per door to ensure maximum size ordered.

Half Height Door - measuring

Elevate and FreeGlide have been designed to feature a 25mm downward compensation to make allowance for untrue walls.

Please check all measurements prior to ordering, and contact our Technical Team if you have any queries.

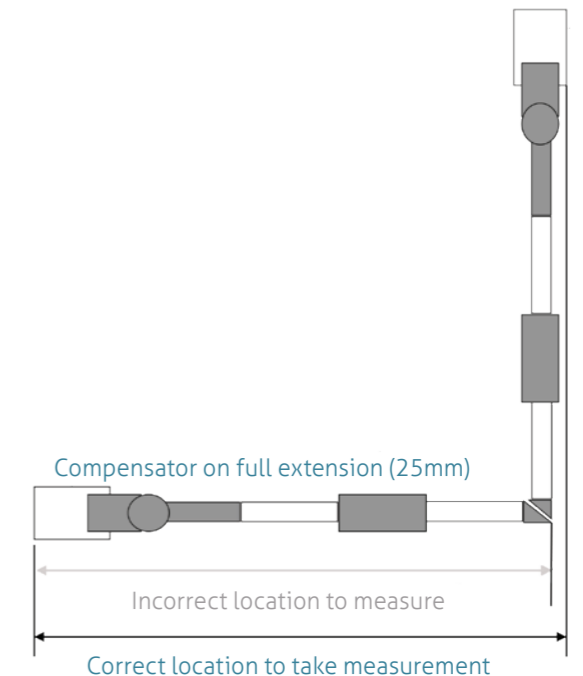

For advice and support on any of our products, call our Technical team on 01460 256080 or visit www.impeyshowers.com

Half Height Shower Doors

Elevate

Intuitive and easy lifting door design

CE CE tested to BS EN 14428

Elevate Bi-Fold Shower Door

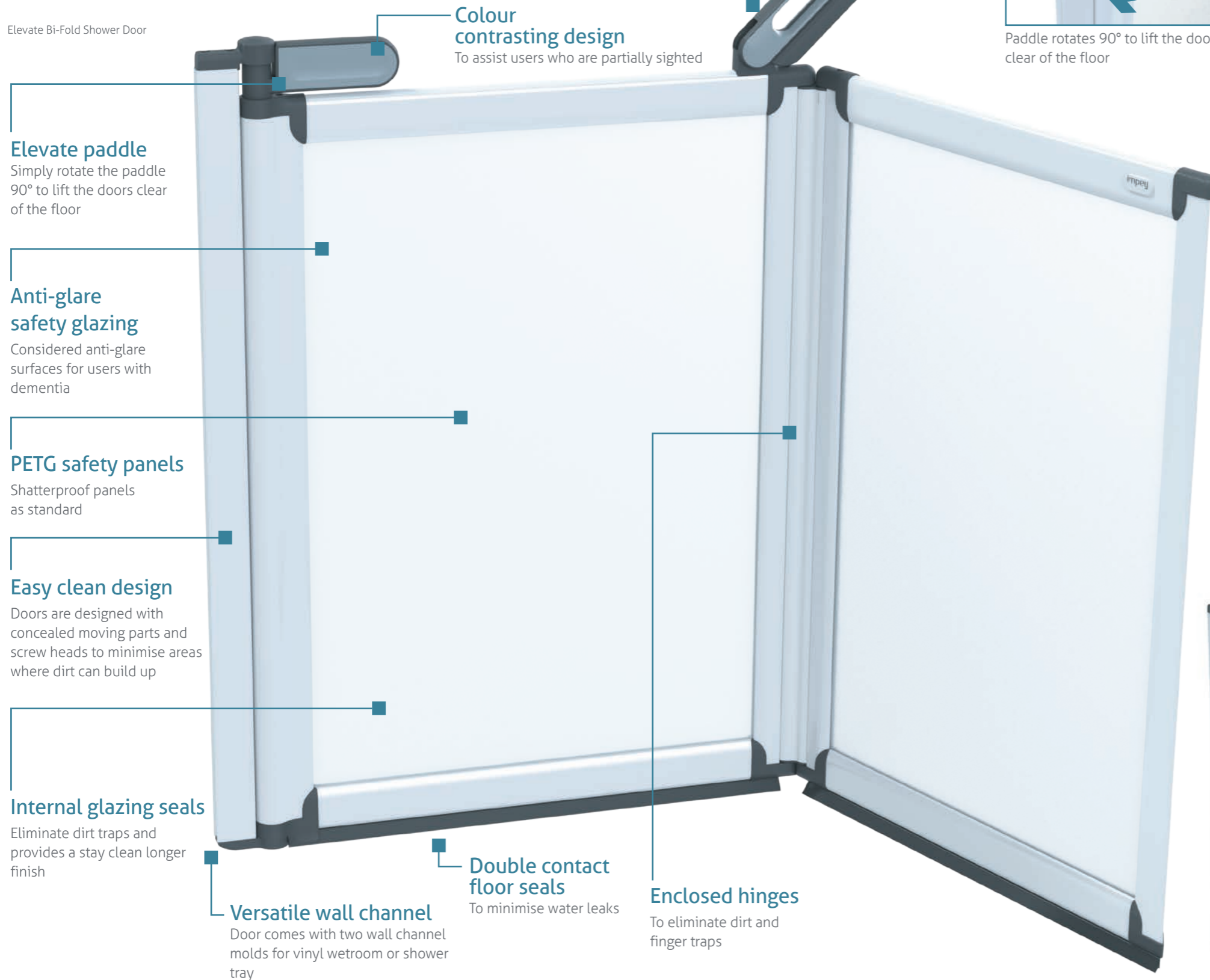

Easy to grasp latch handle
No grip required for users with limited strength or mobility by simply placing your hand through and lifting

Colour contrasting design
To assist users who are partially sighted

Elevate paddle
Simply rotate the paddle 90° to lift the doors 90° to lift the doors clear of the floor

Anti-glare safety glazing
Considered anti-glare surfaces for users with dementia

PETG safety panels
Shatterproof panels as standard

Easy clean design
Doors are designed with concealed moving parts and screw heads to minimise areas where dirt can build up

Internal glazing seals
Eliminate dirt traps and provides a stay clean longer finish

Versatile wall channel
Door comes with two wall channel molds for vinyl wetroom or shower tray

Double contact floor seals
To minimise water leaks

Enclosed hinges
To eliminate dirt and finger traps

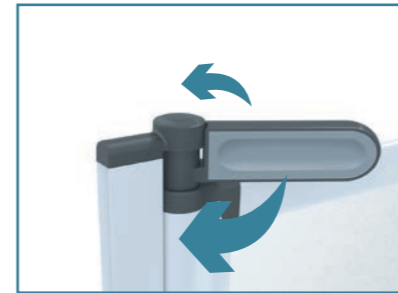

Paddle rotates 90° to lift the doors clear of the floor



Bi-Fold Door only
Latch handle lifts up and down to lock doors into place



Bi-Fold Door only
Bi-Fold Doors can be folded back to allow for wider opening and storage

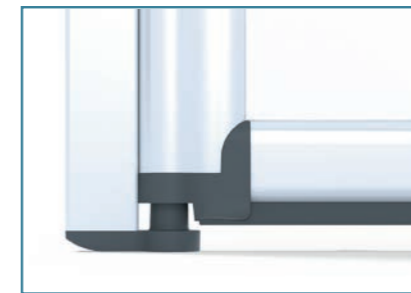

15mm
When the door is opened, the Elevate door rises to create a 15mm gap. This is from the bottom of the seal to the top of the shower tray or vinyl floor

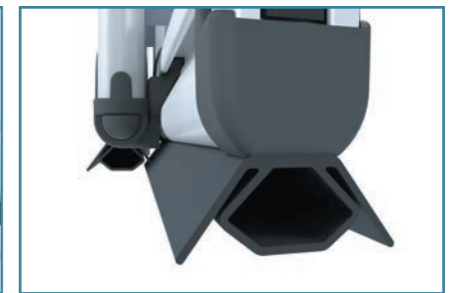

Double contact seals minimises water leaks

Elevate doors can be installed on vinyl or onto a shower tray due to the versatile wall channel. See Floor and Door Options on Pages 88 - 93



For vinyl wetroom install

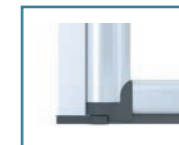

For shower tray install



Elevate Sliding Shower Door



View Elevate Half Height Doors video



Lifetime Guarantee details on Page 94



Made in the UK. See Pages 4 - 7

Half Height Shower Doors

FreeGlide

Assured quality and advanced design features from the industry's leading brand

CE CE tested to BS EN 14428

FreeGlide Sliding Shower Door



Easy clean

Simple unclip feature for thorough cleaning. Doors are designed with concealed moving parts and screw heads to minimise areas where dirt can build up

Easy to use

No grip required for users with limited strength and mobility by simply placing your hand through and sliding

Easy action

Easy to use FreeGlide rising hinge

Versatile wall channel

Door comes with two wall channel molds for vinyl wetroom or shower tray

Enclosed hinges

To eliminate dirt and finger traps

Double contact floor seals

To minimise water leaks

Shatterproof PETG panels as standard

Easy on the eye

Considered anti-glare surfaces for users with dementia

FreeGlide Bi-Fold Shower Door



Bi-Fold Doors can be folded back to allow for wider opening and storage

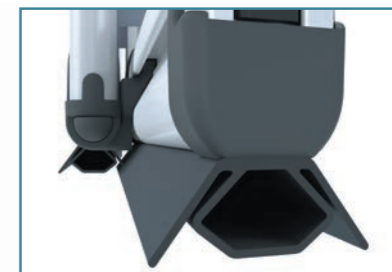

Double contact seals minimises water leaks



Unique sliding door unclip pivot mechanism - no tools required



No grip required for users with limited strength and mobility by simply placing your hand through

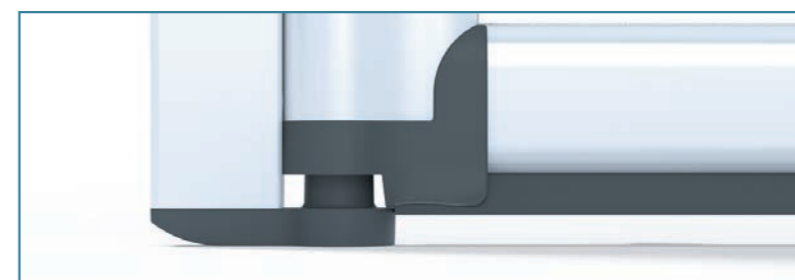

10mm When the door is opened, the FreeGlide design allows for a 10mm gap at the bottom. This is from the bottom of the seal to the top of the shower tray or vinyl floor

FreeGlide doors can be installed on vinyl or onto a shower tray due to the versatile wall channel. See Floor and Door Options on Pages 88 - 93



For vinyl wetroom install



For shower tray install



View FreeGlide Half Height Doors video



Lifetime Guarantee details on Page 94



Made in the UK. See Pages 4 - 7

Shower Doors

Double Bi-Fold Doors

Create a high-end looking vinyl bathroom for level-access showering

The Double Bi-Fold Doors are the ultimate solution where space, safety and access are restricted, but aesthetics still count.



With the addition of our new Coving Profiles, the doors can be installed onto a vinyl floor without a threshold.

The bi-folding design allows both doors to be folded back to the wall to give a large opening, making it extremely practical for wheelchair use. This design makes it the perfect door when maximum space is advantageous.

Features & Benefits

- Minimal frameless design, 2000mm high
- Doors can be installed onto vinyl flooring for level-access showering
- Easy to fit – no fixing to the floor
- Vinyl continues seamlessly up the wall – guaranteed waterproofing
- Easy to use – soft, effortless folding doors
- Warmer showering environment – surrounded by enclosure
- Concealed fixing & seamless profiles – aesthetically pleasing
- Easy to clean – ‘Stay clean glass’, removable seals, concealed fixings & seamless profiles (no dirt traps)
- Space-saving – rising hinge mechanism, set at 90° allowing doors to be folded back to the wall
- Toughened safety glass – BS EN 12150 and BS EN 12600 standard
- Soft-touch handle – acts as bump stop and good grip for user
- CE certified and compliant to BS EN 14428
- Profile and hinges pivot 180° – extremely versatile
- Soft, ultra-clear seals
- Versatile doors - can be installed in a corner or alcove



- Doors come pre-assembled – for easy install
- Door profiles have pre-drilled holes
- 20mm screwless adjustment per profile
- Coving Profiles are pre-cut
- In-house Technical Team to support

Product sizes & codes	Width (mm)	Height (mm)	Pack size	Product code
Double Bi-Fold Door	760	2000	1	P8CB76CUC
Double Bi-Fold Door	800	2000	1	P8CB80CUC
Double Bi-Fold Door	900	2000	1	P8CB90CUC
Double Bi-Fold Door	1000	2000	1	P8CB10CUC
Coving Profile	30	2000	1	P8CBICEPC



Corner installation



Alcove installation

Corner installation on vinyl	Overall size (mm)	Height (mm)	Adjustment range width (mm)	Adjustment per end (mm)
Double Bi-Fold Door (760) + Coving Profile x 2	760 x 760	2000	765 - 785	20
Double Bi-Fold Door (800) + Coving Profile x 2	800 x 800	2000	805 - 825	20
Double Bi-Fold Door (900) + Coving Profile x 2	900 x 900	2000	905 - 925	20
Double Bi-Fold Door (1000) + Coving Profile x 2	1000 x 1000	2000	1005 - 1025	20

Alcove installation on vinyl	Overall size (mm)	Height (mm)	Adjustment range width (mm)	Adjustment per end (mm)
Double Bi-Fold Door (760) + Coving Profile x 2	1500	2000	1500 - 1540	20
Double Bi-Fold Door (800) + Coving Profile x 2	1600	2000	1580 - 1620	20
Double Bi-Fold Door (900) + Coving Profile x 2	1800	2000	1780 - 1820	20
Double Bi-Fold Door (1000) + Coving Profile x 2	2000	2000	1980 - 2020	20

Supreme Glass Shower Panels

Luxury combined with practicality

Supreme Glass Shower Panels offer a luxurious appearance, whilst also providing practical support and ease of entry to the shower, fitted on either a wetroom floor or shower tray.

They are supported by a polished aluminium column, which can be ceiling fixed, or wall braced, which offers the option of hanging a shower curtain to provide further screening. The column is secured to the floor with TigerFix, an innovative new fitting that requires no screws and can also be easily removed.

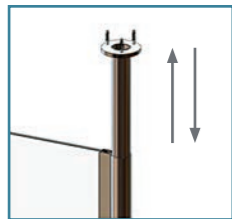

Telescopic pole

Simply adjust to height, twist, lock & secure. No screws or cutting required

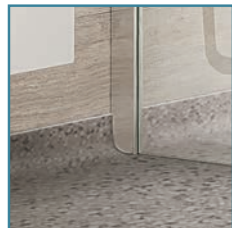

Coving profile

For areas where a coved vinyl floor has been installed you will need to order a coving extension profile

Code: ICEP2000



TigerFix

An innovative adhesive solution that allows easy install without the need for drilling or fixing. It can also be easily removed without causing any damage

Telescopic pole

Can also be attached by wall braced fixing

2000mm high, plain glass with Aqua-Shield Easy Clean Finish

Rigid strong support

8mm toughened safety glass

Shower Panels are available in 5 sizes

700MM, 800MM, 900MM, 1000MM AND 1200MM WIDE

Coving profile

TigerFix



Benefits

- Available in 5 sizes
- Two install options
- Lifetime Guarantee
- CE compliant to BS EN 14428
- Coving extension profile available for vinyl floors
- No breaching of the floor required to fix the pole, protects against water ingress
- Pre-drilled wall profile
- Push in glass profile with 20mm adjustment
- Coving extension profile available
- Secured with innovative TigerFix, so no drilling required to secure pole to floor
- Suitable for use on shower tray or level-access wetroom floor
- All fixings and seals provided
- Fully detailed instructions supplied
- Unbeatable customer service

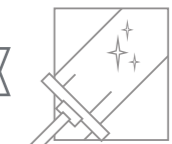

Lifetime Guarantee details on Page 94

Aqua-Shield Easy Clean Finish

Supreme Glass Shower Panels

Floor to ceiling with plain glass

ISS70CUC.	700MM WIDE
ISS80CUC.	800MM WIDE
ISS90CUC.	900MM WIDE
ISS10CUC.	1000MM WIDE
ISS12CUC.	1200MM WIDE

Please note: For areas where a coved vinyl floor has been installed you will need to order a coving extension profile

Code: ICEP2000







Lifetime Guarantee details on Page 94 Aqua-Shield Easy Clean Finish

Wall braced with plain glass

ISSW70CUC.	700MM WIDE
ISSW80CUC.	800MM WIDE
ISSW90CUC.	900MM WIDE
ISSW10CUC.	1000MM WIDE
ISSW12CUC.	1200MM WIDE

Please note: For areas where a coved vinyl floor has been installed you will need to order a coving extension profile

Code: ICEP2000



Shower curtain unavailable for purchase





Lifetime Guarantee details on Page 94 Aqua-Shield Easy Clean Finish

Curtain Rails, Shower Curtains and Screens

Curtain Rails

All the rails are white and made from powder coated aluminium and come complete with fixings which includes, all brackets, screws, rawl plugs, ceiling support rods and shower curtain hooks and gliders.

Bespoke sizes can be made to order.

Product codes & sizes

Curved Rails

SRL-9090W	CURVED RAIL 900 x 900 + FIXING KIT WHITE
SRL-120120W	CURVED RAIL 1200 x 1200 + FIXING KIT WHITE
SRL-13090W	CURVED RAIL 1300 x 900 + FIXING KIT WHITE
SRL-15090W	CURVED RAIL 1500 x 900 + FIXING KIT WHITE
SRL-150120W	CURVED RAIL 1500 x 1200 + FIXING KIT WHITE
SRL-18090W	CURVED RAIL 1800 x 900 + FIXING KIT WHITE

Straight Rails

SRS-130W	STRAIGHT SHOWER RAIL 1.3M + FIXING KIT WHITE
SRS-200W	STRAIGHT SHOWER RAIL 2M + FIXING KIT WHITE
SRS-250W	STRAIGHT SHOWER RAIL 2.5M + FIXING KIT WHITE

U Rails

To be purchased when used in combination with a half height door.

SRU-100100W	U RAIL 1000 x 1000 + FIXING KIT WHITE (W)900mm x (D)950mm
SRU-120120W	U RAIL 1100 x 1150 + FIXING KIT WHITE (W)1092mm x (D)1140mm
SRU-13080W	U RAIL 1300 x 800 + FIXING KIT WHITE (W)1200mm x (D)750mm
SRU-14090W	U RAIL 1400 x 900 + FIXING KIT WHITE (W)1300mm x (D)850mm
SRU-150120W	U RAIL 1500 x 1200 + FIXING KIT WHITE (W)1400mm x (D)1150mm

Shower Curtains

- White only 100% Polyester
- CIBA antibacterial & fungal protection
- Easy care fabric, specially produced for the bathroom
- Machine washable
- Weighted hem to ensure good contact with tray or wet floor
- Range of sizes to suit all showering options



Code	Width x Drop
IC1212	(W)1200 x (D)1200mm
IC181250	(W)1800 x (D)1250mm
IC1818	(W)1800 x (D)1800mm
IC1820	(W)1800 x (D)2000mm
IC1824	(W)1800 x (D)2400mm
IC2018	(W)2000 x (D)1800mm
IC2020	(W)2000 x (D)2000mm
IC2218	(W)2200 x (D)1800mm
IC2220	(W)2200 x (D)2000mm
IC2222	(W)2200 x (D)2200mm
IC2418	(W)2400 x (D)1800mm
IC2420	(W)2400 x (D)2000mm



Made in the UK.
See Pages 4 - 7

Standalone U Rails

These are to be used when not paired with a half height door. All are provided with white fixing kits as standard.

SRUT-9090W	(W)900 x (D)900 STANDALONE U-RAIL
SRUT-100100W	(W) 1000 x (D)1000 STANDALONE U-RAIL
SRUT-120120W	(W) 1200 x (D)1200 STANDALONE U-RAIL
SRUT-13080W	(W) 1300 x (D)800 STANDALONE U-RAIL
SRUT-150120W	(W) 1500 x (D)1200 STANDALONE U-RAIL

Curved Rail Support Rod

The 1.2m trimmable curtain support rod is for installations with high ceilings.

SR-CRSW CURVED RAIL SUPPORT ROD 1.2m + FIXING KIT WHITE

Spare Hooks and Gliders

Spare Curtain rail hooks and gliders for curtain attachment.
SR-HGK SPARE HOOKS & GLIDERS

Window Bridging Kit

The window bridging kit provides a simple solution in situations where a window causes an obstruction during curtain rail installations.

This kit can be used inside the window opening, outside the window opening and dog leg around the window opening.

Pack contains: 1.3m Rail, 1.2m Curtain, 2 corner brackets, pack of hooks and gliders and 2 wall brackets and fittings.

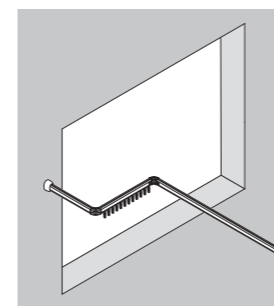

Dog Leg Installation
Window Bridging Kit

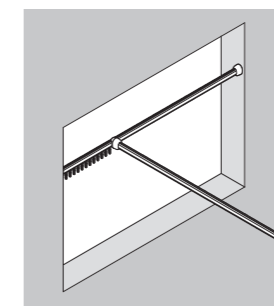

Alcove Window Bridging Kit

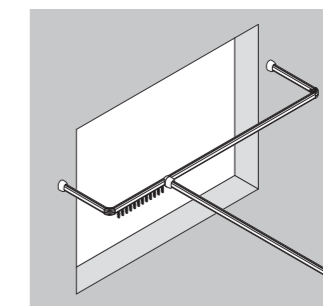

Outer Window Bridging Kit

Product codes & sizes

SR-WBKW WINDOW BRIDGING KIT C/W 1.2 DROP CURTAIN WHITE

Extension Channel Pack

The Extension Channel Pack is used to increase the width of a door or fixed panel from the wall. Each extension kit will increase the width by 20mm.

In a corner installation, 2 packs will be necessary and 2 channels can be combined to increase by 40mm. Each pack contains: 1 wall channel, end cap & fittings.

Product codes & sizes

FG-ECP EXTENSION CHANNEL PACK

Freestanding Carer Screens

Lightweight portable freestanding shower screens offer an instant solution for shower areas that do not require a permanent fixture. 750mm high and made from white powder coated aluminium with grey handles and flexible floor seals.

All panels are made of semi-transparent and anti-shatter PETG.

Product codes & sizes

FG-IPS1W	FREESTANDING SCREEN 2 PANEL 650MM
FG-IPS2W	FREESTANDING SCREEN 2 PANEL 750MM
FG-IPS3W	FREESTANDING SCREEN 2 PANEL 1000MM
FG-IPS4W	FREESTANDING SCREEN 4 PANEL 2 x 400MM wide + 2 x 225MM wide





A variety of wall-mounted and freestanding options

A shower seat is an important addition to a bathroom adaptation. It's a good idea to assess the size and layout of the showering area and the individual needs of the user before deciding upon an option. Also think about: ease of operation; cleaning; transfer from a wheelchair; need for cushioning; whether the seat is warm to the touch; risk of injury; how attractive the seat looks.

SlimFold range

Pages 60 - 63



Shower Seats, Chairs and Stools

Pages 64 - 65



For advice and support on any of our products, call our Technical team on 01460 256080 or visit www.impeyshowers.com

SlimFold range

Slim, strong and easy to clean



Lifetime Guarantee details on Page 94



Rounded, smooth seats made from flexible polyethylene provide natural padding as well as being comfortable and warm to the touch

No drop down legs eliminating the trip risk for users

Top of the seat is angled back at 4° to allow water to run off the back

- Slim design fits closely to the shower wall
- Seat only protrudes 114mm when folded
- Can support up to 300kg (47 stone)
- Hygienic and easy to clean. Solid surfaces with no dirt traps
- Seat can be mounted as low as 415mm*
- Mechanism designed to easily fold down and prevents the seat from accidentally dropping down
- High quality corrosion resistant steel

*427mm for Horseshoe



SlimFold Shower Seat

SlimFold Shower Bench



SlimFold Horseshoe Shower Seat

SlimFold Seat range - fold down mechanism

To deploy it you simply pull out the front edge so that the rear of the seat slides down and the arms then fold neatly into place. The top of the seat is angled at 4° so that water runs off the back.

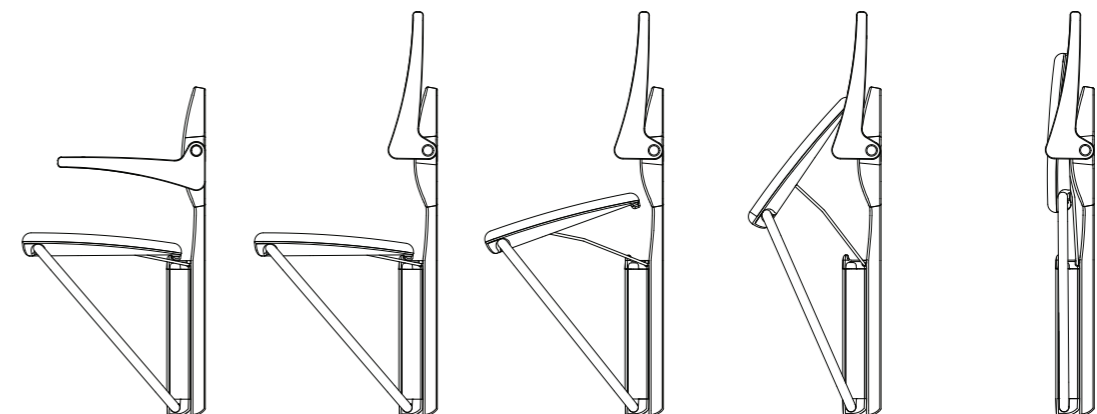

Shower Seats

SlimFold Shower Seat

The most stylish, and practical shower seat on the market



The SlimFold Shower Seat is available either as a full seat with a backrest and arms, or as a bench.

Lifetime Guarantee details on Page 94



When folded the seat has a projection of only 114mm, plus you see the stylish top of the seat, rather than the underside. This is also safer, because it cannot accidentally drop down if knocked. To deploy it you simply pull out the front edge so that the rear of the seat slides down and the arms then fold neatly into place.

Using cross bracing wall supports, instead of traditional floor standing legs, prevents the risk of trapping your toes or banging your feet, or of excessive weight on the legs damaging the floor. It also allows you to mount the seat as low as 415mm if required and the top is slightly angled so that water runs off the back.

SlimFold Shower Seat dimensions

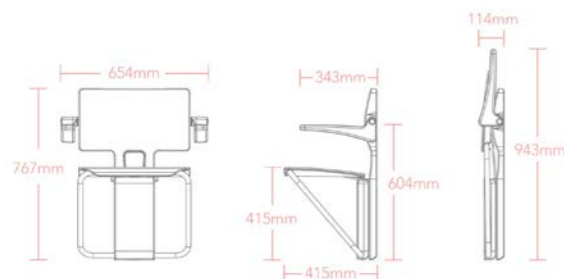

The rounded and smooth seat is comfortable, feels warm to the touch and is easy to use. This revolutionary design, made in Britain using high quality corrosion resistant materials, can support up to 300kg* (47 stone).



Sky Blue
Code: SFS250WSB



Grey
Code: SFS250WGY



White Stone
Code: SFS250WWS



Sandstone
Code: SFS250WSS

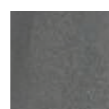

Black Granite
Code: SFS250WBG

All SlimFold Shower Seat designs come as standard with White Stone wall fixed back

*Independently tested to BS12182 and BS12727.
Patent number: GB: 2497432, US: 9101207
*Fixings not included

SlimFold Shower Bench



Lifetime Guarantee details on Page 94

The SlimFold Shower Bench possesses all the features of the SlimFold Shower Seat in terms of colour choice, weight limit and seat folding mechanism. However due to the lack of back and arms it protrudes only 63mm from the wall when folded.

SlimFold Shower Bench dimensions

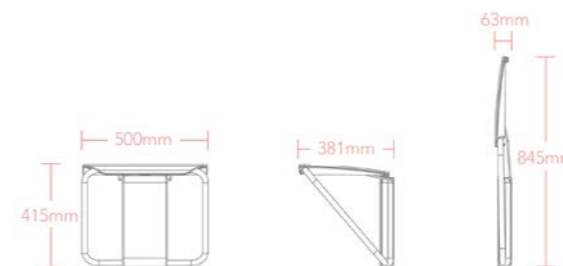

Sky Blue
Code: SFB250WSB



Grey
Code: SFB250WGY



White Stone
Code: SFB250WWS



Sandstone
Code: SFB250WSS

All SlimFold Shower Bench designs come as standard with White Stone wall fixed back



Black Granite
Code: SFB250WBG

SlimFold Horseshoe Shower Seat



Lifetime Guarantee details on Page 94

The SlimFold Horseshoe Shower Seat provides comfort, strength and assurance designed specifically for users who require support and extra assistance of bathing for areas of the body which are harder to reach.

The Horseshoe variation of the popular SlimFold Shower Seat addresses issues for personal intimate cleaning where standard seats restrict access.

SlimFold Horseshoe Shower Seat dimensions



Sky Blue
Code: SFSHS250WSB



Grey
Code: SFSHS250WGY



White Stone
Code: SFSHS250WWS

All SlimFold Horseshoe Shower Seat designs come as standard with White Stone wall fixed back



N.B. All SlimFold range colours are as accurate as the printing process will allow.

Shower Seats

Shower Seats, Chairs and Stools

All of our seats are robust, can be fitted at varying heights and have durable powder coated frames.

All have detachable plastic seat covers for easy cleaning. The seats carry a maximum weight limit of 30 stone (190 kg) unless stated otherwise. Some seats from the range require minimal assembly.

Deluxe Padded Fold Down Shower Seat



Code: S1/P
 Overall size (W x D)
 595mm x 545mm
 Seat size (W x D x H)
 490mm x 380mm x 465mm - 615mm
 Arm size (W)
 Inner: 490mm Outer: 595mm
 Distance from wall in raised position:
 215mm
 Maximum weight limit:
 30 stone (190kg)

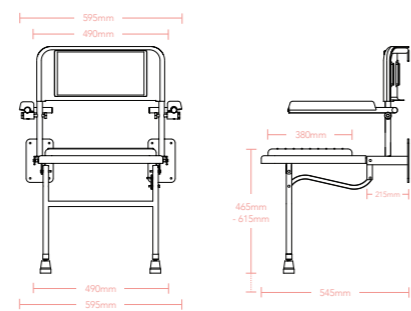

Deluxe Fold Down Shower Seat



Code: S1/
 Overall size (W x D)
 595mm x 545mm
 Seat size (W x D x H)
 490mm x 380mm x 440mm - 590mm
 Arm size (W)
 Inner: 490mm Outer: 595mm
 Distance from wall in raised position
 215mm
 Maximum weight limit:
 30 stone (190kg)

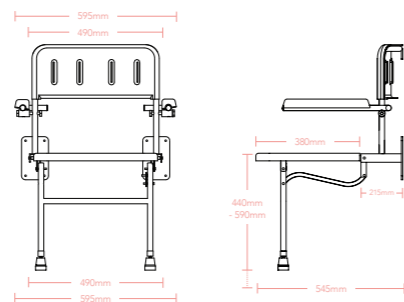

Deluxe Horseshoe Padded Fold Down Shower Seat*



Code: S1/HP
 Overall size (W x D)
 610mm x 558mm
 Seat size (W x D x H)
 437mm x 378mm x 510mm - 555mm
 Arm size (W)
 Inner: 505mm Outer: 610mm
 Distance from wall in raised position:
 175mm
 Maximum weight limit:
 25 stone (160kg)

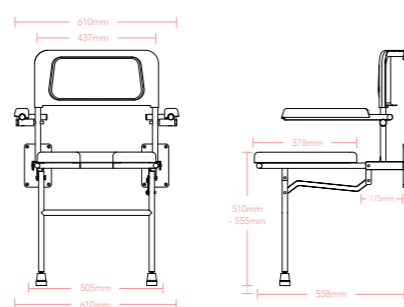

Fold Down Shower Seat



Code: S2/
 Overall size (W x D)
 490mm x 470mm
 Seat size (W x D x H)
 460mm x 380mm x 460mm - 540mm
 Distance from wall in raised position
 98mm
 Maximum weight limit:
 30 stone (190kg)

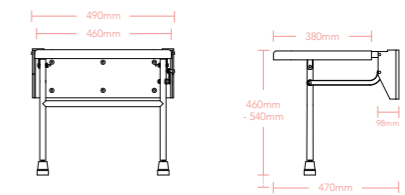

Padded Fold Down Shower Seat



Code: S2/P
 Overall size (W x D)
 490mm x 470mm
 Seat size (W x D x H)
 460mm x 380mm x 485mm - 565mm
 Distance from wall in raised position
 100mm
 Maximum weight limit:
 30 stone (190kg)

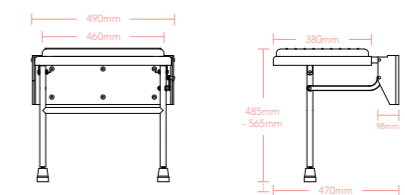

Freestanding Shower Chair*



Code: S5/
 Overall size (W x D)
 535mm x 505mm
 Seat size (W x D x H)
 440mm x 380mm x 480mm - 605mm
 Maximum weight limit:
 15 stone (100kg)

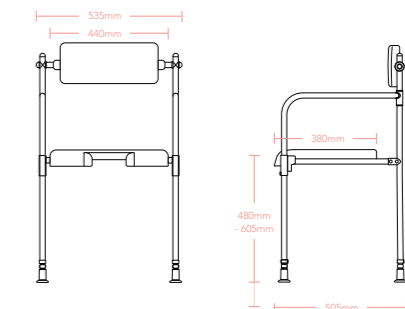

Wide Padded Fold Down Shower Seat*



Code: S9
 Overall size (W x D)
 650mm x 510mm
 Seat size (W x D x H)
 590mm x 420mm x 510mm - 580mm
 Distance from wall in raised position
 100mm
 Maximum weight limit:
 30 stone (190kg)

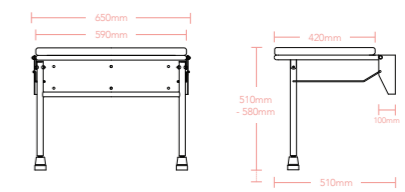

Lifetime Guarantee
 details on Page 94

*Seats come with a 12 month guarantee



For advice and support on any of our products, call our
 Technical team on 01460 256080 or visit www.impeyshowers.com

Maxi-Grip Plus

The strongest, easiest to grip and most versatile hand rail system on the market

A unique and innovative design that redefines what a grab rail should be.



Lifetime Guarantee details on Page 94



Made in the UK. See Pages 4 - 7

- Uses a square aluminium box section as reinforcement for maximum strength
- Supports up to 150kg (23 stone)
- Options for 90°, 60°, 45° or 30° angles
- Modular kits available allowing installers to deliver customised installations
- Available in 1.8m lengths that can be cut to size*
- Can be used for internal or external corners
- Four point wall fixing and flared brackets reduce the stress points creating a secure fixture

*Maximum length for installation is 900mm so must be trimmed down when bought in 1.8m lengths

Square design makes the rail easier to grip firmly and less likely to rotate

Unique co-polymer extrusion gives the corner of the rails soft tactile qualities for increased grip and comfort in wet environments

Developed with the help of the RNIB, colour contrast inserts to help the partially sighted locate the grab rail

Customisable kits

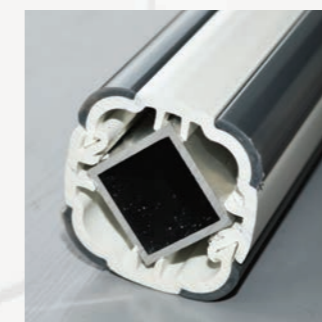

Aluminium core for maximum strength



View Maxi-Grip Plus video



For advice and support on any of our products, call our Technical team on 01460 256080 or visit www.impeyshowers.com

Grab Rails, Hand Rails and Accessories

Maxi-Grip Plus

Maxi-Grip Grab Rails are an innovation from Impey and have been developed with the help of the RNIB. Contains an aluminium core for maximum strength and can support up to 150kg (23 stone). Square design gives better grip and stops the Grab Rail from rotating.

Maxi-Grip Plus with 45° Angle



This is a patented design. Patent number: GB 2 481 259.



90° Angle can be used for internal and external corners



The 90° Adjustable Angle can be trimmed to 60°, 45° & 30° and the 45° can be trimmed to 30°

Maxi-Grip Plus Hand Rail (White/Grey)

Size: 300mm Code: IGS30G
 Size: 450mm Code: IGS45G
 Size: 600mm Code: IGS60G
 Size: 900mm Code: IGS90G

Maxi-Grip Plus Adjustable Angle

Angle: 45° White/Grey Code: IGA45G
 Angle: 90° White/Grey Code: IGA90G

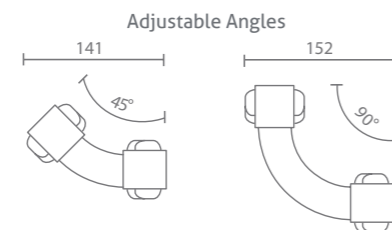

Maxi-Grip Plus Modular Kits

Maxi-Grip Plus provides installers with the ability to provide customised installations with multi-packs of rails, brackets and angle brackets that can be trimmed to size and angled on-site.

1.8m Hand Rail: pack of 4 Code: MGRG184
 End Brackets: pack of 4 Code: MGEBG4
 Trimmable Angles: pack of 4 Code: MGCG4

Note: not to be cut down to lengths above 900mm.

Maxi-Grip

The square profile improves slip resistance, whilst the unique co-polymer extrusion of Maxi-Grip Plus gives the corners of the rails a soft tactile quality for increased grip and comfort.

Maxi-Grip can support loads of up to 150kg (23 stone)*. The range also includes options for 90°, 60°, 45° or 30° angles plus internal and external corners.

*Refers to rails only, not fixings

Maxi-Grip with 90° Angle



Lifetime Guarantee details on Page 94



Made in the UK. See Pages 4 - 7

Maxi-Grip Hand Rail (White)

Size: 300mm Code: IGC30W
 Size: 450mm Code: IGC45W
 Size: 600mm Code: IGC60W
 Size: 900mm Code: IGC90W

Maxi-Grip Adjustable Angle

Angle: 45° White Code: IGA45W
 Angle: 90° White Code: IGA90W

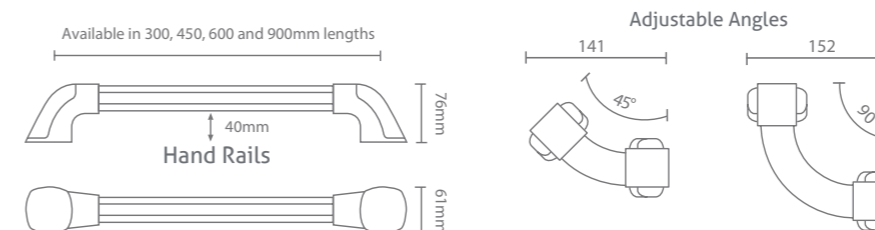

Grab Rails, Hand Rails and Accessories

Hand Rails

Engineered from industrial strength plastics, our satin finished fluted hand rails provide exceptionally good grip in wet environments.

Five screw points on each elbow ensure secure and easy wall fixing, with screw cover plates that snap on easily to provide a neat, easy to clean finish.

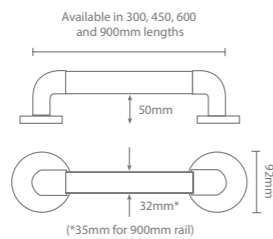

White Hand Rails
 Size: 300mm Code: IG1F
 Size: 450mm Code: IG4F
 Size: 600mm Code: IG5F
 Size: 900mm Code: IG6F

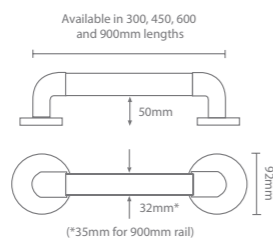

Blue Hand Rails
 Size: 300mm Code: IG1F/Blue
 Size: 450mm Code: IG4F/Blue
 Size: 600mm Code: IG5F/Blue

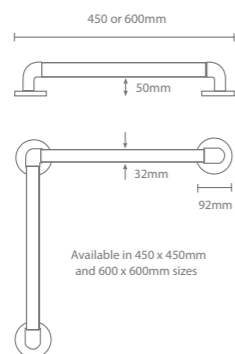

Angular Hand Rails (white only)
 Size: 450mm Code: IG7
 Size: 600mm Code: IG8



Lifetime Guarantee details on Page 94

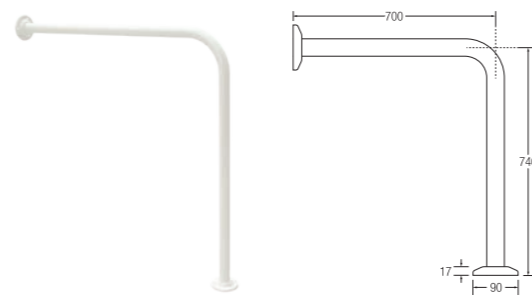

Floor to Wall Hand Rail (white only)
 Code: FWP

The Floor to Wall Hand Rail are manufactured from mild steel with a polyester finish and have an easy grip ribbed surface.



Floor to Ceiling Pole (white only)
 Code: FCP1

The Floor to Ceiling Pole are manufactured from mild steel with a polyester finish and have an easy grip ribbed surface.

Fold Down Rails

We have a large range of Fold Down Rails to offer more assistance in the bathroom. Our robust powder coated rails are available in a variety of sizes and have additional optional extras including toilet roll holders and support legs.

The Fold Down Rails are perfect next to your WC, offering that little extra support when required.

Only available in white.



Fold Down Rails

Size: 550mm Code: DR1
 Size: 760mm Code: DR2
 Size: 760mm with Toilet Roll Holder Code: DR7

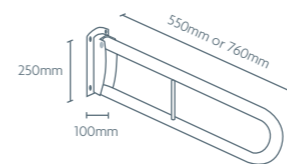

Load Rating 170kg* (26.5 Stone)



Fold Down Single Rail

Size: 760mm Code: DR9

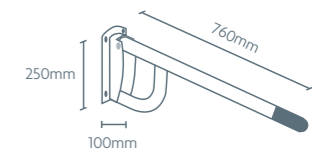

Load Rating 130kg* (20.5 Stone)



Fold Down Rails (with supporting leg)

Size: 550mm Code: DR5
 Size: 760mm Code: DR6
 Size: 760mm with Toilet Roll Holder Code: DR8

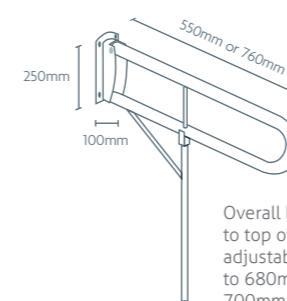

Overall height to top of rail adjustable to 680mm, 700mm and 750mm

Load Rating 200kg* (31.5 Stone)



Fold Down Single Rail (with supporting leg)

Size: 760mm Code: DR10 Load Rating 200kg* (31.5 Stone)

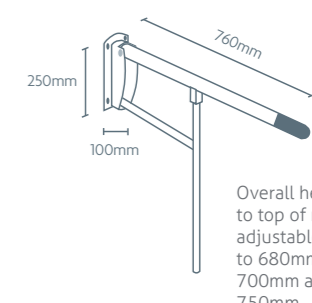

Overall height to top of rail adjustable to 680mm, 700mm and 750mm



Fold Down Rail with Toilet Roll Holder

Size: 760mm Code: DR7

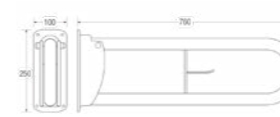

Floor Mounted Post (to suit any hinged rail)

Code: DR3

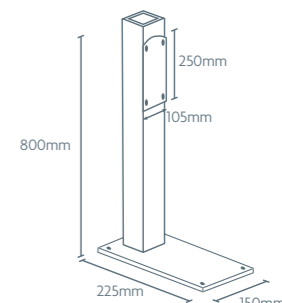

Lifetime Guarantee details on Page 94

* Load ratings tested to BS8300 2009 in the horizontal position

Boston Comfort & Safety Range

Creating the complete solution for a safe and stylish bathroom or wetroom

The Boston Comfort & Safety range enables you to complete your wetroom look with stylish living aid, including a variety of brushed and polished stainless steel accessories, providing a safe bathroom environment for those who do not wish to compromise on style.

■ Load bearing up to 150kg (23 stone)* tested by TÜV

■ 25mm in diameter

■ CE Compliant

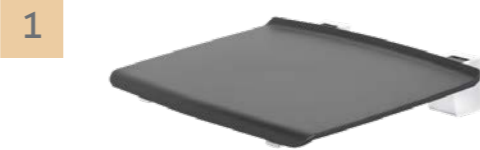

1 Shower Seat Code: Boston Comfort & Safety Shower Seat 299520346

*up to 120kg (18 stone) for Shower Seat



Safety Grab Bar / Toilet Roll Holder	Code:
Safety Grab Bar with Toilet Roll Holder 135° left stainless steel brushed	299120946
Safety Grab Bar with Toilet Roll Holder 135° left stainless steel polished	299120346
Safety Grab Bar with Toilet Roll Holder 135° right stainless steel brushed	299150946
Safety Grab Bar with Toilet Roll Holder 135° right stainless steel polished	299150346



Safety Grab Bar - straight (3 sizes available)	Code:
Safety Grab Bar 30cm stainless steel brushed	297720946
Safety Grab Bar 30cm stainless steel polished	297720346
Safety Grab Bar 45cm stainless steel brushed	297920946
Safety Grab Bar 45cm stainless steel polished	297920346
Safety Grab Bar 90cm stainless steel brushed	298120946
Safety Grab Bar 90cm stainless steel polished	298120346

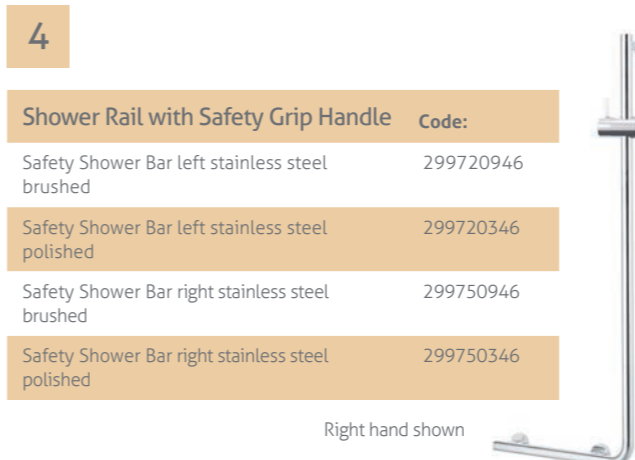

Shower Rail with Safety Grip Handle	Code:
Safety Shower Bar left stainless steel brushed	299720946
Safety Shower Bar left stainless steel polished	299720346
Safety Shower Bar right stainless steel brushed	299750946
Safety Shower Bar right stainless steel polished	299750346

Accessories	Code:
Anti Slip Grip grey	297521046
Organiser grey	297621046



Safety Angled Grab Bar 135°	Code:
Safety Bar 135° left stainless steel brushed	298720946
Safety Bar 135° left stainless steel polished	298720346
Safety Bar 135° right stainless steel brushed	298750946
Safety Bar 135° right stainless steel polished	298750346



Folding Grab Bar	Code:
Folding Grab Bar stainless steel brushed	299230946
Folding Grab Bar stainless steel polished	299230346



Safety Bar 90°	Code:
Safety Bar 90° left stainless steel brushed	298320946
Safety Bar 90° left stainless steel polished	298320346
Safety Bar 90° right stainless steel brushed	298350946
Safety Bar 90° right stainless steel polished	298350346

Toilet Brush and Holder	Code:
Toilet Brush and Holder stainless steel brushed	299920946
Toilet Brush and Holder stainless steel polished	299920346



A range to suit all applications

Impey offer a wide selection of showers from a variety of manufacturers, in order to provide you with the best choice for your requirements. The entire range features thermostatic controls, for added safety, plus you have the option of the finest quality mixer shower, or easy to install electric showers.



Mixer Showers

Page 76



Electric Showers

Pages 77 - 79



For advice and support on any of our products, call our Technical team on 01460 256080 or visit www.impeyshowers.com

Mixer Showers

Features	Mira Select Flex Thermo Mixer Code: MIRASELFLEX	Impey TMV2 Code: TMV2KIT	Impey TMV3 Code: TMV3KIT
Tank/Mains Fed	Tank or Mains	Tank or Mains	Tank or Mains
Pump compatibility Switch Connect	Yes	Yes	Yes
Shower Head	Single spray rub clean nozzles Limescale resistant	3 spray modes Spray, Rinse, Pulse	3 spray modes Spray, Rinse, Pulse
Length of Hose	2m (Anti-Twist)	2m	2m
TMV2/TMV3	TMV2 and TMV3	TMV2	TMV3
WRAS	Yes	Yes	Yes
Warranty	5 years	5 years	5 years



Technical Specification

- Separate flow and temperature controls with extended levers
- Thermostatic temperature stability for safe showering of 1°C
- Adjustable maximum temperature setting for added safety
- Fail safe on hot and cold supplies
- 'Cool Touch' shower valve for added safety
- 'Everclear' limescale resistant showerhead with single spray pattern
- Extended riser rail (1m) and 2m hose
- Wall or corner mounting options
- Variable pipe inlet centres (139-153mm)
- Inlet connection: 15mm compression
- Outlet connection: ½" BSP flat face
- Operating pressure range of 0.1 to 5 bar
- Maximum inlet temperature: 65°C
- Minimum temperature differential to achieve hot or cold failsafe: 12°C
- Suitable for unvented, pressurised, combi-boiler, gravity fed and mains pressure systems
- Guaranteed for 5 years

Technical Specification

- Suitable for use with unvented supplies, combi boilers, gravity and mains pressure systems
- Thermal cartridge technology
- Temperature stability of ± 2°C
- Fail safe protection on both the hot and cold supplies
- Operating pressure range of 0.2 to 5 bar
- TMV2 / WRAS approved
- 5 year warranty

Technical Specification

- Suitable for use with unvented supplies, combi boilers, gravity and mains pressure systems
- Thermal cartridge technology
- Temperature stability of ± 2°C
- Fail safe protection on both the hot and cold supplies
- Operating pressure range of 0.2 to 5 bar
- Safe touch body
- TMV3 / WRAS approved - complies with NHS D08 and BS7942
- 5 year warranty

Electric Showers

Features	Mira Advance Flex 8.7 Code: MIRAADVLEX87	Mira Advance Flex 9.8 Code: MIRAADVLEX98	Mira Advance Flex Extra 8.7 Code: MIRAADVLEXEXT87	Mira Advance Flex Low Pressure Code: MIRAFLEX/LP90
k.W	8.7	9.8	8.7	9.0
Tank/Mains Fed	Cold Mains	Cold Mains	Cold Mains	Tank Fed
Pump compatibility:				
- Bluetooth	No	No	Yes	No
- Switch Connect	Yes	Yes	Yes	Yes
- Wired Pump Connection	No	No	Yes	No
Shower Head	3 spray modes, removable easy clean plate	3 spray modes, removable easy clean plate	3 spray modes, removable easy clean plate	4 spray modes, rub clean nozzles
Length of Hose	2m (Anti-Twist)	2m (Anti-Twist)	2m (Anti-Twist)	2m (Anti-Twist)
BEAB	Yes	Yes	Yes	Yes
RNIB	Yes	Yes	Yes	Yes
WRAS	Yes	Yes	Yes	Yes
Warranty	2 years	2 years	2 years	2 years



Technical Specification

- Pumped electric shower - the ideal choice for low pressure sites
- Separate flow and temperature controls with push button start/stop and audible beeps
- Thermostatic temperature control for added safety
- Four spray pattern showerhead with rub clean rubber nozzles for easy cleaning
- Extended riser rail (1m) with easy one-handed adjustment of the height of the shower head, plus additional parking socket
- Best in class limescale resistance
- Guaranteed for 2 years, with optional 3 year extended warranty

Technical Specification

- Easily accessible controls with high contrast on critical touch points
- Four different maximum temperature settings
- Anti-glare matte finish to panels
- Phased shutdown flushes hot water from the tank to make it safe for next user
- Suitable to be paired with the Whale Switch Connect Pump

Technical Specification

- Specifically designed to be compatible with the Whale Instant Match Bluetooth Pump using Easy Pair technology. A digital signal from the shower automatically adjusts the pump speed in relation to the shower flow rate.
- Easily accessible controlled with high contrast on critical touch points
- Four different maximum temperature settings
- Anti-glare matte finish to panels
- Phased shutdown flushes hot water from the tank to make it safe for next user

Technical Specification

- Pumped electric shower - the ideal choice for low pressure sites
- Separate flow and temperature controls with push button start/stop and audible beeps
- Thermostatic temperature control for added safety
- Four spray pattern showerhead with rub clean rubber nozzles for easy cleaning
- Extended riser rail (1m) with easy one-handed adjustment of the height of the shower head, plus additional parking socket
- Best in class limescale resistance
- Guaranteed for 2 years, with optional 3 year extended warranty

Electric Showers

Features	Triton Omnicare Design 8.5 Code: CINCDES08W	Triton Omnicare Design 9.5 Code: CINCDES09W	Redring Selectronic Premier Plus 8.5 Code: RSELP85P
k.W	8.5	9.5	8.5
Tank/Mains Fed	Cold mains	Cold mains	Cold mains
Pump compatability:			
- Bluetooth	No	No	No
- Switch Connect	Yes	Yes	Yes
- Wired Pump Connection	Yes	Yes	No
Shower Head	5 spray modes, rub clean nozzles	5 spray modes, rub clean nozzles	6 spray modes, rub clean handset
Length of Hose	2m (Anti-Twist)	2m (Anti-Twist)	2m
BEAB	Yes	Yes	Yes
RNIB	Yes	Yes	Yes
WRAS	No	No	Yes
Warranty	2 years	2 years	3 years



The entire range features thermostatic controls, for added safety

Technical Specification

- Thermostatic temperature reassurance - Regulates water temperature within +/-1°C
- Audible feedback and tactile temperature dial with soft grey tones offers assistance to visually impaired users
- Easy operation – A soft press start/stop power button and looped lever handle offer low resistance control of the shower
- Safe-set™ - Allows the maximum temperature to be set whilst allowing full rotation of temperature dial
- 2m Anti-Twist hose
- Ease of replacement – Includes multiple cable & water entry points, generous footprint & a fixing hole kit.
- Connects to both analogue and digital waste pumps

Technical Specification

- Thermostatic temperature reassurance - Regulates water temperature within +/-1°C
- Audible feedback and tactile temperature dial with soft grey tones offers assistance to visually impaired users
- Easy operation – A soft press start/stop power button and looped lever handle offer low resistance control of the shower
- Safe-set™ - Allows the maximum temperature to be set whilst allowing full rotation of temperature dial
- 2m Anti-Twist hose
- Ease of replacement – Includes multiple cable & water entry points, generous footprint & a fixing hole kit.
- Connects to both analogue and digital waste pumps

Technical Specification

- Separate temperature controls with large push button start/stop and audible bleeps
- Clear print control identification for ease of visibility and legibility
- Large LED temperature readout display
- Thermostatic temperature control for added safety
- Adjustable maximum temperature setting for added safety
- Eco Water-Save feature that automatically calculates and adjusts the optimum flow rate.
- Phased shutdown reduces limescale and ensures a cool start for added safety for the next user.
- Automatic shutdown after 30 minutes of inactivity
- 6 spray pattern shower head with rub clean nozzles for easy cleaning
- Extended riser rail (1m) with 2m hose
- Guaranteed for 3 years, with optional 2 year extended warranty

Features	Redring Selectronic Premier Plus 9.5 Code: RSELP95P	Bristan Joy Care 8.5 - Long Hose/Long Dial Code: JOYTHCKH85 W	Bristan Joy Care 9.5 - Long Hose/Long Dial Code: JOYTHCKH95 W
k.W	9.5	8.5	9.5
Tank/Mains Fed	Cold mains	Cold mains	Cold mains
Pump compatability:			
- Bluetooth	No	No	No
- Switch Connect	Yes	Yes	Yes
- Wired Pump Connection	No	No	No
Shower Head	6 spray modes, rub clean handset	3 spray modes, rub clean anti-limescale	3 spray modes, rub clean anti-limescale
Length of Hose	2m	2m	2m
BEAB	Yes	Yes	Yes
RNIB	Yes	Yes	Yes
WRAS	Yes	Yes	Yes
Warranty	3 years	5 years	5 years



Technical Specification

- Separate temperature controls with large push button start/stop and audible bleeps
- Clear print control identification for ease of visibility and legibility
- Large LED temperature readout display
- Thermostatic temperature control for added safety
- Adjustable maximum temperature setting for added safety
- Eco Water-Save feature that automatically calculates and adjusts the optimum flow rate.
- Phased shutdown reduces limescale and ensures a cool start for added safety for the next user.
- Automatic shutdown after 30 minutes of inactivity
- 6 spray pattern shower head with rub clean nozzles for easy cleaning
- Extended riser rail (1m) with 2m hose
- Guaranteed for 3 years, with optional 2 year extended warranty

Technical Specification

- Warm up mode - illuminated start/stop button flashes when shower is switched on and stops when temperature is reached
- Max temperature setting (factory set at 41°C) adjustable at installation from 37°C-45°C
- Automatic shut off (factory set at 30 minutes), adjustable at installation to 5, 10, 20 or 30 minutes
- Digital setting readout
- Raised markings on the end of the dial
- Audible bleeps/clicks confirm chosen settings
- Intelligent phased shutdown
- Error code read out - allows for quick assessment of problem diagnostics
- Extra long hose and dial for ease of use.

Technical Specification

- Warm up mode - illuminated start/stop button flashes when shower is switched on and stops when temperature is reached
- Max temperature setting (factory set at 41°C) adjustable at installation from 37°C-45°C
- Automatic shut off (factory set at 30 minutes), adjustable at installation to 5, 10, 20 or 30 minutes
- Digital setting readout
- Raised markings on the end of the dial
- Audible bleeps/clicks confirm chosen settings
- Intelligent phased shutdown
- Error code read out - allows for quick assessment of problem diagnostics
- Extra long hose and dial for ease of use

Showers & Waste Pump Kits

Wireless controlled pumped drainage options

For drainage that requires a waste pump we offer showers which provide a more economical and easy to install solution.

These showers can be directly connected to the waste water pump rather than fitting a separate flow switch or sensor, together with the additional wiring connections.

The latest innovation from Mira and Whale provides wireless control pumped drainage, reducing installation time and the need for additional wiring between the pump and the shower.

Whale Instant Match Bluetooth Pump



- 1 **Transformer** - Initiates start-up of the pump. Regulates the flow rate and controls pump shut down.
- 2 **A flow sensor** in the shower communicates to the transformer via Bluetooth wireless technology.
- 3 **Instant Match with Bluetooth wireless technology pump** - Quiet running waste pump. Designed to pump up to 8 litres per minute. The pump has integral non-return valves and requires no filter.
- 4 **Gullies** - Matching the pump speed to the shower flow rate ensures that gully suction noise is minimised.

Maximum distance from the gully to the pump is 3 metres.



Watch how Whale Instant Match Bluetooth Pump Kit and Mira Advance Flex Extra shower work together

UK Manufacturers - Mira Showers and Whale

Mira Showers

Hull and Cheltenham, England

"Across both our Cheltenham and Hull sites, we continually invest in innovative manufacturing processes to ensure that we deliver the highest quality products, every time."

Whale

Bangor, Northern Ireland

"Our Whale Healthcare products are 100% water tested to ensure reliability and quality every time."



Discover more about our UK Manufacturing Partners

Integral sensors ensure the pump flow rate matches the shower flow rate to provide the most efficient drainage. This also reduces noise output considerably, whilst also reducing wear on the pump.

	Mira & Whale Advance Flex Extra 8.7kW & Instant Match Bluetooth Pump Code: MIRIM/BT	Impey & Whale TMV2 & Instant Match Premium Code: TMV2/IMP
Mixer or Electric shower	Electric	Mixer
Pump capacity	Up to 8 litres/minute	Up to 12 litres/minute
Bluetooth technology	Yes	No
BEAB	Yes	No
RNIB	Yes	No
WRAS	Yes	Yes
TMV2/TMV3	No	TMV2
Warranty	2 years on shower / 5 years on pump	5 year warranty



TMV2/IMP must be bought alongside the Fast fix Bracket kit. Code: 20010CP



Technical Specification

- Featuring Bluetooth 'Easy Pair' technology between the shower and pump
- Specially designed to be partnered with the Whale Instant Match Premium Pump
- Easily accessible controls with high contrast on critical touch points
- Four different maximum temperature settings
- Anti-glare matte finish to panels
- Phased shutdown flushes hot water from the tank to make it safe for next user
- Wireless flood prevention two way communications between the shower and the pump reduces risk of flooding if the power to the pump is turned off.



Technical Specification

- Temperature stability of $\pm 2^{\circ}\text{C}$
- Fail safe protection on both the hot and cold supplies
- Operating pressure range of 0.2-0.5 bar
- TMV2/WRAS approved
- Quiet operation to pump with built in anti-vibration mounts.
- Acoustically tested
- Latest switch mode technology in the transformer
- New self cleaning flow sensor technology
- No need for filters
- Plug and play installation

Showers & Waste Pump Kits

Shower Waste Pump Kits can be fitted when gravity drainage is not an option. The pump is activated by a flow switch or flow sensor installed in the water supply to the shower.

When the shower is turned on water passes through the flow switch or flow sensor, activating the pump. Alternatively we offer one pump that is controlled directly by a connection to an electric shower, without the need for a flow switch.

All our pumped kits are suitable for wetroom floors or shower trays and include all the fittings needed for a single feed electric shower installation, but please note that for mixer showers you will need a Mixer Shower Conversion Kit and for wetroom floors you will require a TAD13 shallow waste gully (see page 39).



Whale Switch Connect Kit Code: SWP

This is the original waste pump kit and has been successfully installed in over 150,000 homes across the UK.

Technical Specification

- Maximum drainage for electric showers 8l/min
- Maximum drainage for mixer showers 12ltrs per minute (additional mixer valve conversion kit required) SWP/MX
- Self priming pump with protective cover
- Low voltage transformer conforms to EN60742
- 12 adjustable settings for electric & mixer showers
- Active link diagnostics
- De-puddling cycle: pump turns on for a brief period, 15 min after shower is turned off
- IP45 Rated



Whale Direct Connect Kit Code: SWP/WM

Based on the Switch Connect original waste pump kit, the Direct Connect kit is designed for direct connection to electric showers without the need for a flow switch.

Technical Specification

- Designed for electric showers only. Direct connection compatibility with electric shower is required
- Maximum drainage for electric showers 8l/min
- Self priming pump with protective cover
- Low voltage transformer conforms to EN60742
- 12 adjustable settings for electric & mixer showers
- Active link diagnostics
- De-puddling cycle: pump turns on for a brief period, 15 min after shower is turned off
- IP45 Rated

	Whale Switch Connect Pump Kit	Whale Direct Connect Pump Kit	Whale Instant Match Bluetooth Pump Kit	Whale Instant Match Premium Pump Kit
Code	SWP	SWP/WM	SWP/IMBT	SWP/IMP
Warranty	3 years (extended to 5 years with registration)	3 years (extended to 5 years with registration)	3 years (extended to 5 years with registration)	3 years (extended to 5 years with registration)
Bluetooth Compatible	No	No	Yes with Mira Advance Flex Extra (MIRAADVFLXEXT87)	No
Noise reduction / Anti-vibration	No	No	Available as an upgrade	Yes
Maximum drainage capacity (litres per min)	Max drainage for mixer = 12l per min Max drainage for electric = 8l per min	Max drainage for electric = 8l per min	Max drainage for electric = 8l per minute	Max drainage for mixer = 12l per min Max drainage for electric = 8l per min
External switch to run the pump	No	No	Yes	Yes
Auto shower-stop (Mira showers only)	No	No	Yes (bluetooth operated)	Yes
Shower compatibility	Mixer showers and electric showers	Electric showers	Electric showers	Mixer showers and electric showers



Whale Instant Match Bluetooth Pump Kit Code: SWP/IMBT

Designed to be specifically compatible with the Mira Advance Flex Extra using Easy Pair bluetooth technology. A digital signal from the shower automatically adjusts the pump speed in relation to the shower flow rate.

Technical Specification

- Maximum drainage 8l/min
- Self priming pump with protective cover
- Low voltage transformer conforms to EN60742
- Active Link Diagnostics
- Anti-flood feature with Mira Advance Flex Extra* - turns shower off if no power on pump
- IP45 rated

*Purchase the Mira Advance Flex Extra and Bluetooth pump together using code MIRIM/BT



Whale Instant Match Premium Pump Kit Code: SWP/IMP

Quiet operation, because the speed is regulated depending on the flow rate of water from the shower. This reduces noise output considerably, whilst also reducing wear on the pump.

Technical Specification

- Maximum drainage 12l/min
- Automatically adjusts to changes in shower flow rate
- Compensates for changes in voltage from main electric supply
- Self priming pump with protective cover
- Low voltage transformer conforms to EN60742
- IP45 rated



For advice and support on any of our products, call our Technical team on 01460 256080

5 YEAR WARRANTY
ON ALL WHALE KITS



Whale Pump Service Kit Code: SWP/DT

Suitable for:

- Whale Switch Connect Kit Code: SWP
- Whale Direct Connect Kit Code: SWP/WM



Also includes two 22mm push-fit fixtures

Whale Mixer Shower Conversion Kit for SWP Pump Code: SWP/MX

When fitting the pump in conjunction with a mixer shower this mixer shower conversion kit is required.

Suitable for:

- Whale Switch Connect Kit Code: SWP



Tricuspid/non-return valves - pack of 10 Code: SWP/TV



Whale 15mm Flow Switch Kit Code: SWPFS

Suitable for:

- Whale Switch Connect Kit Code: SWP



Whale Spare Pump Head Code: SWP/PH

Suitable for:

- All Impey Whale shower waste pumps



Whale Spare Pump Only Code: SWP/PO

Suitable for:

- Replacement of all Impey Whale shower waste pumps



Whale Pump Transformer for Switch Connect Code: SWP/TMK2

Suitable for:

- Whale Switch Connect Kit Code: SWP



Whale Pump Transformer for Instant Match Kit Code: SWP/IMBT

Suitable for use with

- Whale Instant Match Premium Pump Kit Code: SWP/IMP

Toilets and Bathroom Accessories

Palma Vita Automatic WC

The Closomat Palma Vita Automatic WC shower toilet provides flushing, warm water washing, and warm air drying from one simple operation. Simple to operate, it is purpose-designed to combine a conventional WC with an integrated washing and drying cycle. It is the only toilet of its kind, specifically developed for elderly and disabled people, designed to properly support the user and position them correctly for effective washing and drying. It is user-friendly for people who have restricted use of their hands. By reducing hand contact, it also provides improved hygiene for all users. The Touch Sensitive Switch can be placed on the floor and operated by a foot, eliminating hand contact, if required.

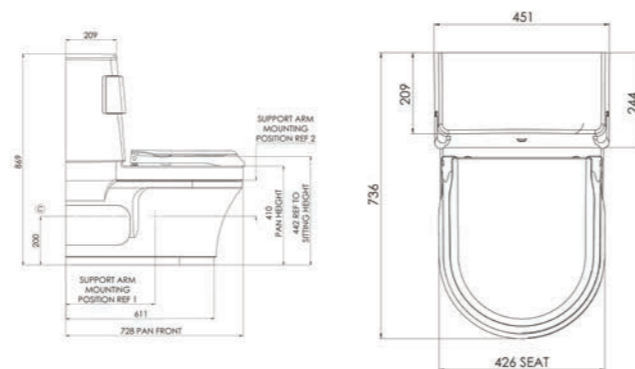

Simultaneous flushing and washing

This unique feature improves personal hygiene - cleaning with water, not paper. Can be used at all times as a conventional WC.

Combines functions of a WC and bidet with the addition of drying air.

The Palma Vita's unique one-touch system allows the user to benefit from the toilet's automatic functions by just pressing and releasing the flush. Wash time adjustable to client needs.



Safe working load: 190kg (30 stone)
Maximum user weight: 362kg (57 stone) when fitted with Big John Seat.

Made in a dedicated plant within the UK.

Closomat Optional Extras

There is a range of accessories available for the Palma Vita Automatic WC including seats, integrated fold down support arms, lateral body supports, plinths to raise the height and a touch pad for those who cannot use the flush button.



Soft Seat Code: SOFTSEAT | Fold Down Support Arms Code: FOLDDOWNARMS | Lateral Body Supports Code: LATERALBODYSUPPORTS | Big John Seat Code: BIGJOHNSEAT | Palma Vita Toilet Plinth Code: SHAPEDPLINTH | Touch Sensitive Hand/Foot Switch Code: HAND/FOOTSWITCH

Bathroom Accessories

Toilet Plinths

For wheelchair users and people with limited mobility conventional toilets can be too low and very difficult to use.

The Impey toilet plinths have been designed to raise the existing toilet to account for these needs. Their non-intrusive design allows for greater flexibility in the bathroom and removes the need to purchase a new toilet while remaining discreet.

25mm Toilet Plinth Code: IP25
Raises the height of the toilet by 25mm

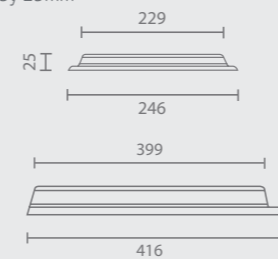

50mm Toilet Plinth Code: IP50
Raises the height of the toilet by 50mm

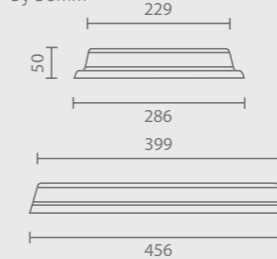

75mm Toilet Plinth Code: IP75
Raises the height of the toilet by 75mm

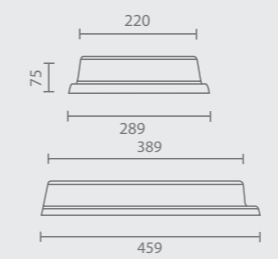

100mm Toilet Plinth Code: IP100
Raises the height of the toilet by 100mm

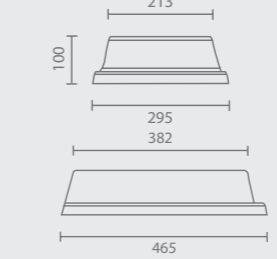

Back to Wall Plinths are available. Codes: IPBW25, IPBW50, IPBW75, IPBW100

Impey Plastic Access Panels

The Plastic Access Panel is designed to fit into any wall and ceiling where access is required to stopcocks, pipes etc. Or simply use to fill unsightly holes, saving the need for expensive repairs. The high impact styrene plastic with UV stabilisers will not fade or corrode.

- Easy installation
- 3mm thick High Impact Styrene Plastic with UV stabilisers
- White textured exposed surfaces, which allow for painting
- Available in 4 sizes:

152 x 228	Code: AP1523
203 x 203	Code: AP2020
300 x 300	Code: AP3030
355 x 355	Code: AP3535

Apres Body Dryer

Code: BODYDRYER

The Apres Body Dryer is a complete all-over body dryer.

Tested to rigorous safety standards, it fits neatly into most bathing and shower areas and helps make towels a thing of the past.

Technical Specification

- Height: 2075mm
- Voltage: 220/240V
- Normal output: 2.9kW
- Average air outlet temperature: 20°C
- 2 speed on/off air switch
- ABS plastic construction
- Tested to EN60 335-2-23 1990
- Sound level: 70dB
- 3 year warranty.



Extractor fans by Xpelair

- Flow straighteners guide air through ducting which reduces turbulence, smoothing and making the air flow laminar
- A cone reduces turbulence in front of the fan and air is directed straight into the impeller
- Ball-bearing motors suppress noise from the motor.



NEW Simply Silent Intermittent Extractor Fan with Timer Square/Round Code: C4TSR (Note: both square and round cap are included)

Simply Silent Fan Kit Low Voltage

Code: LV100T

Simply Silent DC Low Voltage Constant Volume Fan with external transformer Round or Square

Round Code: LVCV4R

Square Code: LVCV4S



Toilets and Bathroom Accessories

Sankit Range

The contract, care and commercial sanitary-ware range looks beautiful and delivers improved practicalities.

With eighteen options available, this range offers an ideal choice to suit the preferences of the end-user as well as budget.

The toilets are available in 390mm or 460mm high, standard soft close seat and cover as well as choice of a level flush or push button.

		No Basin required
1 Tap Basin	2 Tap Basin	
IMPSAN1	IMPSAN2	IMPSAN13
IMPSAN3	IMPSAN4	IMPSAN14
IMPSAN5	IMPSAN6	IMPSAN15
IMPSAN7	IMPSAN8	IMPSAN16
IMPSAN9	IMPSAN10	IMPSAN17
IMPSAN11	IMPSAN12	IMPSAN18



- Close Coupled Comfort Height Pan
- 460mm High
- Soft Close Seat and Cover
- Lever Flush Cistern (including fittings)



- Close Coupled Comfort Height Pan
- 460mm High
- Soft Close Seat and Cover
- Push Button Flush Cistern (including fittings)



- Close Coupled Pan
- 390mm High
- Soft Close Seat and Cover
- Lever Flush Cistern (including fittings)



- Close Coupled Pan
- 390mm High
- Soft Close Seat and Cover
- Push Button Flush Cistern (including fittings)



- Low Level Pan
- 460mm High
- Soft Close Seat and Cover
- Low Level Lever Flush Cistern (including fittings)



- Low Level Pan
- 390mm High
- Soft Close Seat and Cover
- Low Level Lever Flush Cistern (including fittings)

Toilets

Our range of products are comfortable, practical and better designed to suit the needs of users.

Close Coupled Pan

The attractive contemporary style of the suite takes comfort products to a new level. The suite features a close coupled box rim P trap WC with a choice of either raised height single push button or conventional lever flush cistern. Both options give an economical 6 litre flush. All seats and covers come with soft close as standard.

Low Level Pan

A traditional low level style elevated pan with a choice of either raised height single push button or conventional lever flush BIBO cistern. Both options give an economical 6 litre flush. All seats and covers come with soft close as standard.

Basins

Smart and attractively designed this compact basin will suit all applications. Available with either 1 or 2 tap hole options with matching semi-pedestal.

500mm 1th Basin with Mono Basin Mixer Tap



Click Clack Waste, Semi-ped, Basin brackets, Bottle trap, Flexible Tails*, Semi-pedestal fixing brackets

*Copper Tails are available at an additional cost

500mm 2th Basin with 3" Basin Lever Taps



Click Clack Waste, Semi-ped, Basin brackets, Bottle trap, Semi-pedestal fixing brackets



Thermostatic Mixing Valve (TMV2) 15mm



TMV2 is designed to eliminate the risk of scalding and are suitable for use in a wide range of public, health care, social, commercial and domestic applications.



TMV2 15mm
Code: IMPSANTMV

Doc M Close Coupled Packs

A stylish Doc M Close Coupled toilet suite which would not look out of place in any bathroom or toilet setting. The Doc M suite has a hygienic high gloss white glaze finish and superior flushing performance and is available with spatula lever handle.

For ease of installation the pack is universal and the basin can be installed on either side of the WC. The cistern spatula lever can also be fitted on the left or right hand side to suit the required orientation and comes with a blank for the unused hole. All necessary fittings such as the basin sequential mixer tap, basin waste, bottle trap and cistern spatula handle together with the hinged support rail and grab rails in white or blue are included.



Doc M Pack

Close Coupled White
Code: IMPSAN19

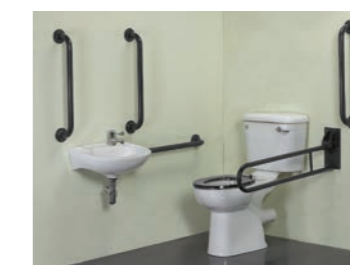

Doc M Pack

Close Coupled Blue
Code: IMPSAN20

For advice and support on any of our products, call our Technical team on 01460 256080 or visit www.impeyshowers.com

Floor and Door Options

Wetroom floor Corner

All corner options can be supplied with L-shaped curtain rail and curtain. All door configurations are available left or right handed (left hand illustrated).

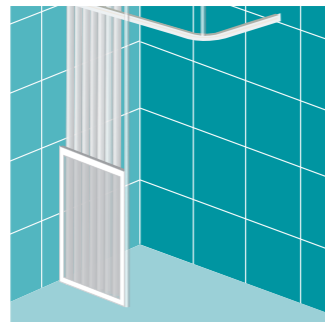

Option C
Fixed 750mm wide half height fixed panel, floor to ceiling pole

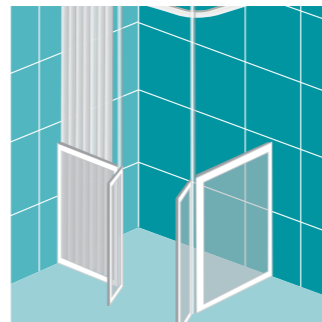

Option D
Two fixed half height panels, one 400mm on front, with floor to ceiling poles with one door hung from each panel



Option E
400mm fixed half height panel with floor to ceiling pole and a pair of bi-fold doors meeting on corner

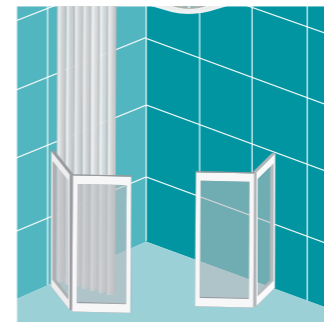

Option H
Two half height bi-fold doors meeting on the corner



Option J
One bi-fold and single door meeting on the corner



Option 1
Pair of sliding doors meeting on the corner



Option 6
Fixed 400mm half height panel, floor to ceiling pole with pair of sliders meeting a return pair of sliders on the corner

Floor Former	SIZE	Option C	Option D	Option E	Option H	Option J	Option 1	Option 6
Level-Dec EasyFit	800 x 800	•	•	•	•	•	•	•
	900 x 900	•	•	•	•	•	•	•
	1000 x 1000	•	•	•	•	•	•	•
	1200 x 750	•	•	•	•	•	•	•
	1200 x 900	•	•	•	•	•	•	•
	1200 x 1200	•	•	•	•	•	•	•
	1300 x 800	•	•	•	•	•	•	•
	1400 x 900	•	•	•	•	•	•	•
	1500 x 800	•	•	•	•	•	•	•
	1500 x 1200	•	•	•	•	•	•	•
	1700 x 750*	•	•	•	•	•	•	•
	1850 x 900*	•	•	•	•	•	•	•

For door options with Level-Grade please call our Technical team on 01460 256080

Wetroom floor Alcove

All alcove options can be supplied with L-shaped curtain rail and curtain. All door configurations are available left or right handed (left hand illustrated).

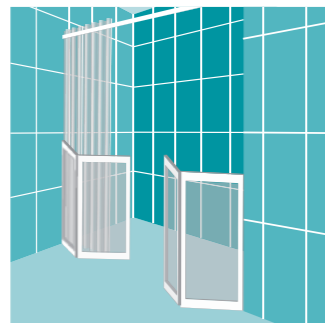

Option G
Two half bi-fold doors meeting in the middle

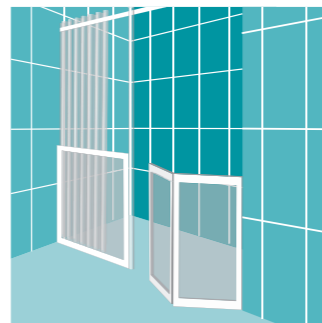

Option M
One bi-fold door meeting fixed 400mm panel with floor to ceiling pole



Option 2
One set of sliding doors hung off one side latching on opposite wall



Option 3
One fixed half height 400mm panel with floor to ceiling pole and one sliding door hung from opposite wall



Option 4
Pair of sliding doors hung between walls meeting in middle

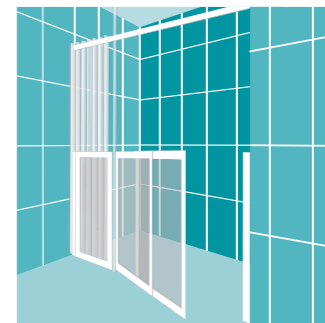

Option 5
One 400mm fixed half height panel with floor to ceiling pole, one sliding door hung off pole and latching on opposite wall

Special and Bespoke Half Height Door sizes available in Elevate and FreeGlide

Multiple variations and sizes are available in both ranges

For advice and support on any of our products, call our Technical team on 01460 256080 or visit www.impeyshowers.com

Floor Former	SIZE	Option G	Option M	Option 2	Option 3	Option 4	Option 5
Level-Dec EasyFit	800 x 800	•	•	•	•	•	•
	900 x 900	•	•	•	•	•	•
	1000 x 1000	•	•	•	•	•	•
	1200 x 750	•	•	•	•	•	•
	1200 x 900	•	•	•	•	•	•
	1200 x 1200	•	•	•	•	•	•
	1300 x 800	•	•	•	•	•	•
	1400 x 900	•	•	•	•	•	•
	1500 x 800	•	•	•	•	•	•
	1500 x 1200	•	•	•	•	•	•
	1700 x 750*	•	•	•	•	•	•
	1850 x 900*	•	•	•	•	•	•

*Door options for Mendip Bath Replacement Tray, Radiate Bath Replacement Tray, Mantis Bath Replacement Tray, Level-Dec EasyFit 1700x750 and 1850x900 cut to length, SL3517075 and MEN701 are only suitable if they are fitted full size (not trimmed to length)

Floor and Door Options

Shower Tray

Corner

All corner options can be supplied with L-shaped curtain rail and curtain. All door configurations are available left or right handed (left hand illustrated).



Option C
Fixed 750mm wide half height fixed panel, floor to ceiling pole

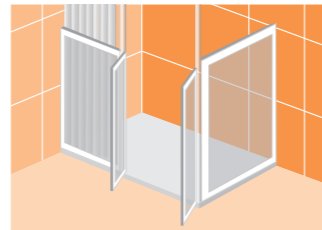

Option D
Two fixed half height panels, one 400mm on front, with floor to ceiling poles on front, with floor to ceiling poles with one door hung from each panel

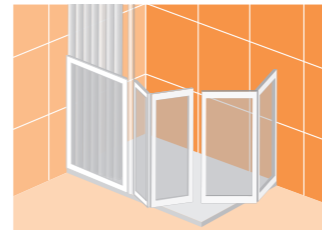

Option E
400mm fixed half height panel with floor to ceiling pole and a pair of bi-fold door meeting on corner

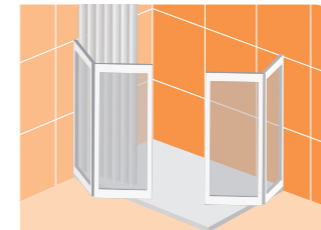

Option H
Two half height bi-fold doors meeting on the corner

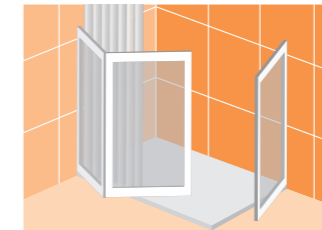

Option J
One bi-fold and single door meeting on the corner

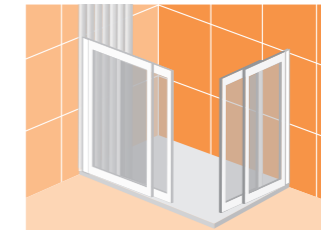

Option 1
Pair of sliding doors meeting on the corner

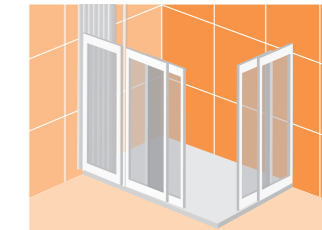

Option 6
Fixed 400mm half height panel, floor to ceiling pole with pair of sliders meeting a return pair of sliders on the corner

Shower Tray	CODE	SIZE							
Slimline	SL358080	800 x 800	•						
	SL359090	900 x 900	•						
	SL35100100	1000 x 1000	•						
	SL3512075	1200 x 750	•	•					•
	SL3512090	1200 x 900	•	•	•				•
	SL3513070	1300 x 700	•	•	•				•
	SL3513075	1300 x 750	•	•	•				•
	SL3515075	1500 x 750	•	•	•				•
SL3517075*	1700 x 750	•	•	•				•	
Slimline Bath Replacement Tray	BRT129M	1200 x 900	•	•	•				•
	BRT1775M	1700 x 750	•	•	•				•
	BRT1785M	1700 x 850	•	•	•				•
Mendip	MEN501	900 x 900	•						
	MEN601	1000 x 1000	•						
	MEN101	1250 x 710	•	•					•
	MEN201	1250 x 830	•	•	•				•
	MEN301	1500 x 710	•	•	•				•
	MEN401	1500 x 830	•	•	•				•
	MEN701*	1850 x 710	•	•	•				•
Radiate	RDT9090/P	900 x 900	•						
	RDT100100/P	1000 x 1000	•						
	RDT12070/P	1200 x 700	•	•					•
	RDT12080/P	1200 x 800	•	•	•				•
	RDT12090/P	1200 x 900	•	•	•				•
	RDT13070/P	1300 x 700	•	•	•				•
	RDT13080/P	1300 x 800	•	•	•				•
	RDT14070/P	1400 x 700	•	•	•				•
	RDT14080/P	1400 x 800	•	•	•				•
	RDT14090/P	1400 x 900	•	•	•				•
	RDT15070/P	1500 x 700	•	•	•				•
	RDT15080/P	1500 x 800	•	•	•				•
	RDT17070/P	1700 x 700	•	•	•				•
RDT17080/P	1700 x 800	•	•	•				•	
Mantis	MTS9090	900 x 900	•						
	MTS100100	1000 x 1000	•						
	MTS12070	1200 x 700	•	•					•
	MTS12080	1200 x 800	•	•	•				•
	MTS13070	1300 x 700	•	•	•				•
	MTS13080	1300 x 800	•	•	•				•
	MTS14070	1400 x 700	•	•	•				•
	MTS14080	1400 x 800	•	•	•				•
	MTS15070	1500 x 700	•	•	•				•
	MTS15080	1500 x 800	•	•	•				•
	MTS17070	1700 x 700	•	•	•				•
	MTS17080	1700 x 800	•	•	•				•

*Door options for Mendip Bath Replacement Tray, Radiate Bath Replacement Tray, Mantis Bath Replacement Tray, Level-Dec EasyFit 1700x750 and 1850x900 cut to length, SL3517075 and MEN701 are only suitable if they are fitted full size (not trimmed to length)



For a comprehensive list of tray and floor former sizes call our Technical team on 01460 256080 or visit www.impeyshowers.com

Floor and Door Options

Shower Tray Alcove

All alcove options can be supplied with straight curtain rail and curtain. All door configurations are available left or right handed (left hand illustrated).

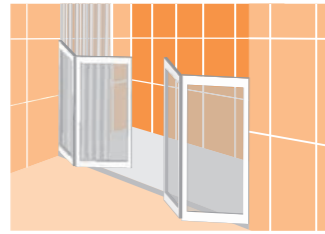

Option G
Two half bi-fold doors meeting in the middle

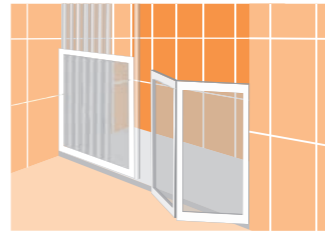

Option M
One bi-fold meeting fixed 400mm panel with floor to ceiling pole

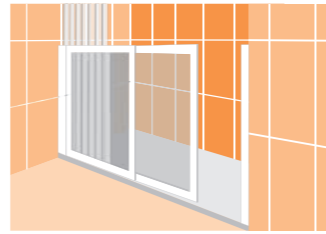

Option 2
One set of sliding doors hung off one side latching on opposite wall

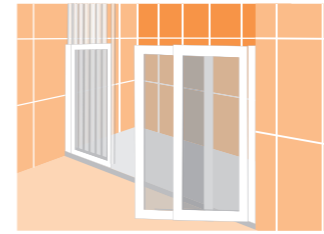

Option 3
One fixed half height 400mm panel with floor to ceiling pole and one sliding door hung from opposite wall

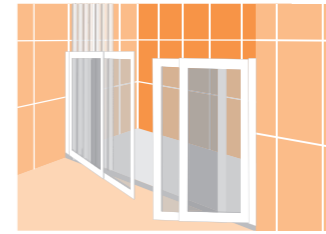

Option 4
Pair of sliding doors hung between walls meeting in middle

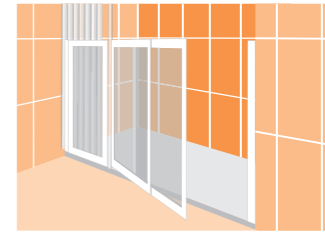





Option 5
One 400mm fixed half height panel with floor to ceiling pole, one sliding door hung off pole and latching on opposite wall

Special and Bespoke Half Height Door sizes available in Elevate and FreeGlide

Multiple variations and sizes are available in both ranges

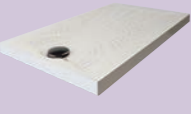
For advice and support on any of our products, call our Technical team on 01460 256080 or visit www.impeyshowers.com

Shower Tray	CODE	SIZE							
Slimline 	SL358080	800 x 800							
	SL359090	900 x 900							
	SL35100100	1000 x 1000							
	SL3512075	1200 x 750	•	•	•	•	•	•	•
	SL3512090	1200 x 900	•	•	•	•	•	•	•
	SL3513070	1300 x 700	•	•	•	•	•	•	•
	SL3513075	1300 x 750	•	•	•	•	•	•	•
	SL3515075	1500 x 750	•	•	•	•	•	•	•
	SL3517075*	1700 x 750	•	•	•	•	•	•	•
Slimline Bath Replacement Tray	BRT129M	1200 x 900	•	•	•	•	•	•	•
	BRT1775M	1700 x 750	•	•	•	•	•	•	•
	BRT1785M	1700 x 850	•	•	•	•	•	•	•
Mendip 	MEN501	900 x 900							
	MEN601	1000 x 1000							
	MEN101	1250 x 710	•	•	•	•	•	•	•
	MEN201	1250 x 830	•	•	•	•	•	•	•
	MEN301	1500 x 710	•	•	•	•	•	•	•
	MEN401	1500 x 830	•	•	•	•	•	•	•
	MEN701*	1850 x 710	•	•	•	•	•	•	•
Radiate 	RDT9090/P	900 x 900							
	RDT100100/P	1000 x 1000							
	RDT12070/P	1200 x 700	•	•	•	•	•	•	•
	RDT12080/P	1200 x 800	•	•	•	•	•	•	•
	RDT12090/P	1200 x 900	•	•	•	•	•	•	•
	RDT13070/P	1300 x 700	•	•	•	•	•	•	•
	RDT13080/P	1300 x 800	•	•	•	•	•	•	•
	RDT14070/P	1400 x 700	•	•	•	•	•	•	•
	RDT14080/P	1400 x 800	•	•	•	•	•	•	•
	RDT14090/P	1400 x 900	•	•	•	•	•	•	•
	RDT15070/P	1500 x 700	•	•	•	•	•	•	•
	RDT15080/P	1500 x 800	•	•	•	•	•	•	•
	RDT17070/P	1700 x 700	•	•	•	•	•	•	•
RDT17080/P	1700 x 800	•	•	•	•	•	•	•	
Mantis 	MTS9090	900 x 900							
	MTS100100	1000 x 1000							
	MTS12070	1200 x 700	•	•	•	•	•	•	•
	MTS12080	1200 x 800	•	•	•	•	•	•	•
	MTS13070	1300 x 700	•	•	•	•	•	•	•
	MTS13080	1300 x 800	•	•	•	•	•	•	•
	MTS14070	1400 x 700	•	•	•	•	•	•	•
	MTS14080	1400 x 800	•	•	•	•	•	•	•
	MTS15070	1500 x 700	•	•	•	•	•	•	•
	MTS15080	1500 x 800	•	•	•	•	•	•	•
	MTS17070	1700 x 700	•	•	•	•	•	•	•
MTS17080	1700 x 800	•	•	•	•	•	•	•	

*Door options for Mendip Bath Replacement Tray, Radiate Bath Replacement Tray, Mantis Bath Replacement Tray, Level-Dec EasyFit 1700x750 and 1850x900 cut to length, SL3517075 and MEN701 are only suitable if they are fitted full size (not trimmed to length).



Lifetime Guarantee

Impey guarantees its range of branded showering products against faulty materials or manufacture for a lifetime, provided that they have been installed and maintained in accordance with the manufacturer's instructions.

The guarantee extends to non-electrical products in general use and excludes normal wear and tear. For products such as taps, shower valves, bathroom accessories, waterproofing and electrical products, the standard manufacturer's guarantee will apply. Where products included in the Lifetime Guarantee are used for commercial use, such as hospitals, nursing homes or hotels, a 5 year guarantee will be applicable.

Parts that are defined as wearing parts, such as seals, seat pads etc, are subject to a 5 year guarantee.

If in our opinion the product has been modified, neglected, misused or is the subject of accidental damage the guarantee will not be applicable.

Impey has a policy of continuous improvement and therefore reserves the right to revise or amend the specification of any product without notice.

In situations where a product has failed, subject to the terms of the guarantee, and a direct replacement is no longer available, Impey will replace it with the nearest equivalent product.

The liability of Impey does not extend to consequential loss or damage arising from the defective product and is limited to the price of the original goods supplied by Impey.

The guarantee is in addition to your statutory rights.

Sankit Range Guarantee (Pages 86 - 87)



Our 10 year warranty applies to all ceramic sanitary products, excluding normal wear and tear in general domestic applications.



Our 5 year warranty applies to 3" Lever Basin excluding normal wear and tear in general domestic applications.



Our 2 year warranty applies to the Push Button Flush and TMV2 15mm, excluding normal wear and tear in general domestic applications.



Our 12 month warranty applies to all internal components, excluding normal wear and tear in general domestic applications.

Please note, our warranty on all products does not include installation or third party damage, or any form of impact damage and must be in accordance to relevant local and national regulations.

Full terms and conditions available on our website www.impeyshowers.com

Level-Dec EasyFit, Maxi-Grip, Radiate, Mendip and Mantis are all trademarks of Impey

Impey

Conquest Business Park
Cad Road
Ilton
Somerset
TA19 9EA

Part of the Coram Group

01460 256080
www.impeyshowers.com
salesorders@impeyshowers.com

Impey

Conquest Business Park, Cad Road,
Ilton, Somerset, TA19 9EA

@impeyshowers



Whilst every care has been taken to ensure that the information included in this document was accurate at the time of printing, we reserve the right to change product specifications at any time without prior notice.

The photographs reproduced in this document publication are within the constraints of the printing process and are not to be used for matching purposes. All photographs are used for approximate representation only and may not show the actual products on offer. Errors and Omissions Excepted.

Full terms and conditions available at www.impeyshowers.com

07/2021